



940nm 1000mW VCSEL with Diffuser in 3535 Package

Model No. VCD35A-940H1Wx

Features

- 3535 package
- Low wavelength drift
- Oxide isolation technology
- Low threshold current
- Easy to collimate
- 1W 940nm VCSEL @ 1.3A

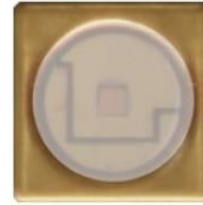

3535 Package with Diffuser

Applications

- 3D sensor
- Gesture recognition
- IR illumination
- Medical application
- Broadband access network

Specifications

Absolute Maximum Ratings				
Parameters	Symbol	Rating	Unit	Conditions
Case Operating Temperature	Top	-40 to 85	°C	
Storage Temperature	Tstg	-40 to 105	°C	
Reflow Soldering Temperature	Tsol	260	°C	10 seconds
Reverse Voltage	Vr	3	V	
Maximum Continuous Current	I _{max}	1.6	A	
ESD Exposure (Human Body) Model	ESD	2K	V	

Notes:

- Stresses greater than those listed under “Absolute Maximum Ratings” may cause permanent damage to the device. This is a stress rating only and functional operation of the device at these or other conditions above those indicated in the operations section for expanded periods of time may affect reliability.
- In its maximum rating diode laser operation could damage its performance or cause potential safety hazard such as equipment failure.
- Electrostatic discharge is the main reason for laser fault of the diode. Take effective precautions against ESD. When dealing with laser diodes, use wrist strap, grounding work surface and strict antistatic technology.

Electro-Optical Characteristics (T _{op} =25°C, CW Mode)						
Parameters	Symbol	Min.	Typ.	Max.	Unit	Conditions
Optical Output Power	P _o	-	1000	-	mW	I _F =1.3A
Threshold Current	I _{th}	-	0.2	-	A	
Forward Current	I _F	-	1.3	-	A	
Power Conversion Efficiency	η	-	35	-	%	I _F =1.3A
Slope Efficiency	SE	-	0.82	-	W/A	P _o =1W
Peak Wavelength	λ _p	930	940	950	nm	I _F =1.3A
Spectral Width	FWHM _s	-	2.8	-	nm	
Forward Voltage	V _f	-	2.17	-	V	I _F =1.3A
Series Resistance	R	-	0.5	-	Ohm	I _F =1.3A
Wavelength Temperature Drift	Δλ _p / ΔT	-	-	0.07	nm/°C	I _F =1.3A
Beam Divergence	FWHM _B	-	20	-	deg	
Substrate	AlN					

Note: Electro-optical characteristic with a package or diffuser would require further evaluation. Values are based on limited sample size and estimated values.



Typical Characteristics

LIV Graph

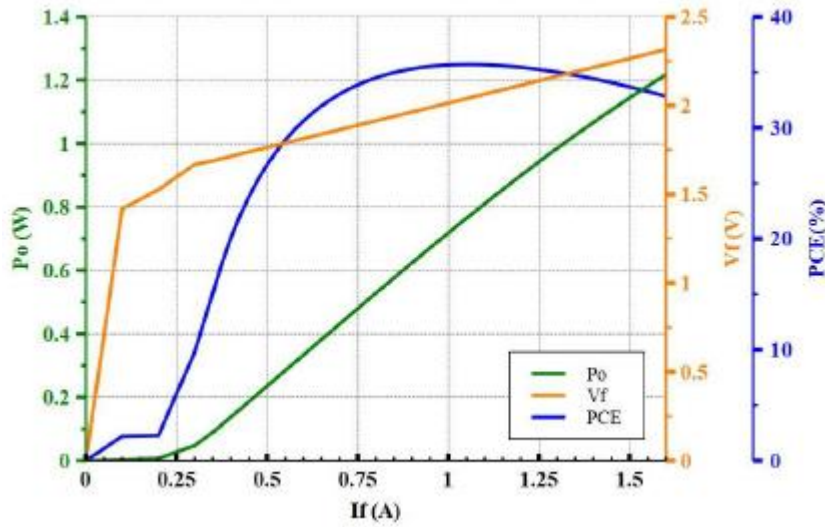

Intensity vs. Wavelength

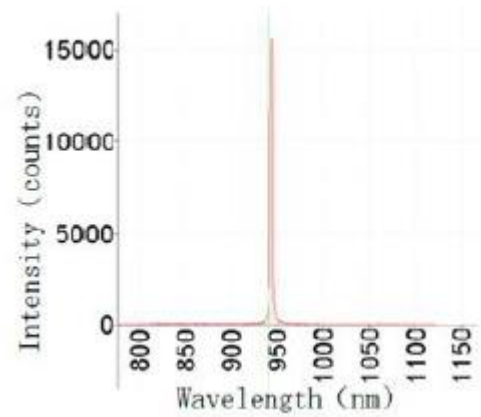

Outline Dimensions (unit: mm)

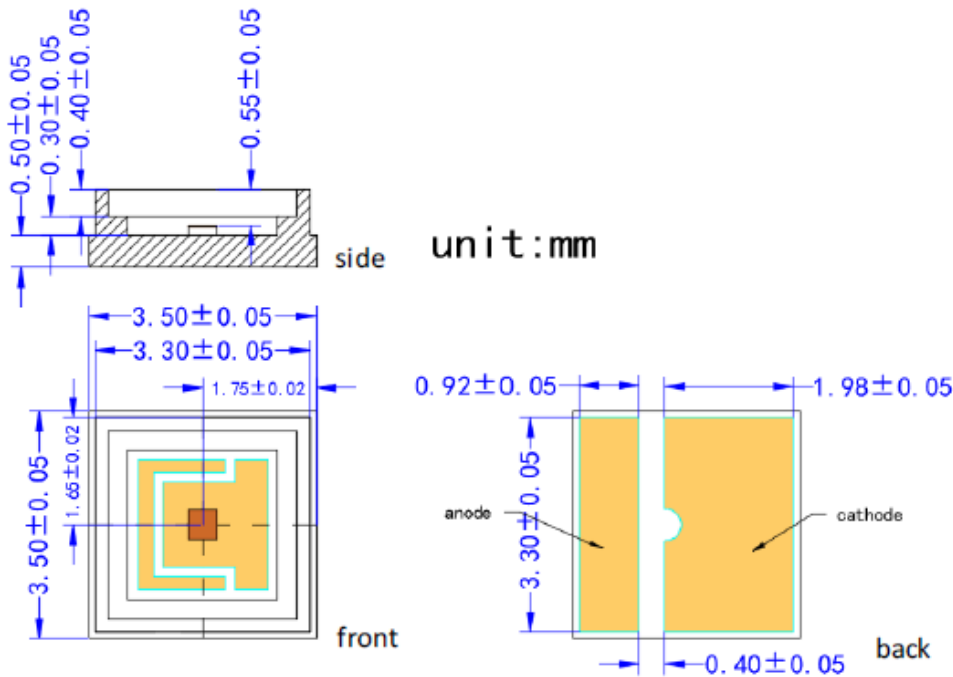

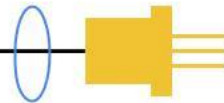

Typical Laser Spot and Beam Profile with Diffuser

Beam angle: 60°x45°

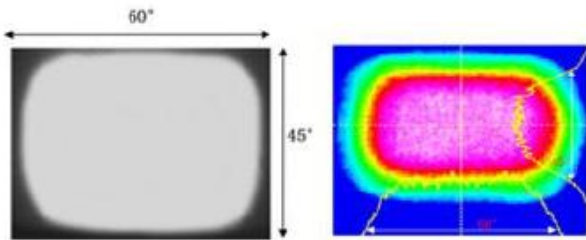

Beam angle: 72°x58°

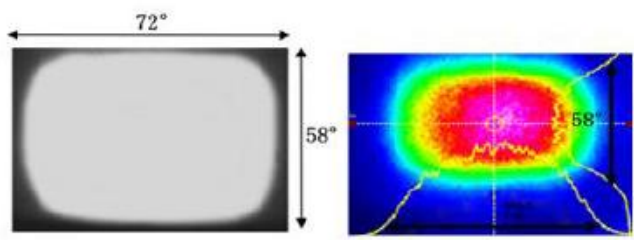

Beam angle: 90°x70°

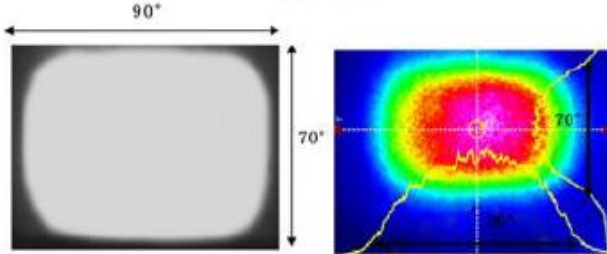

Beam angle: 110°x85°

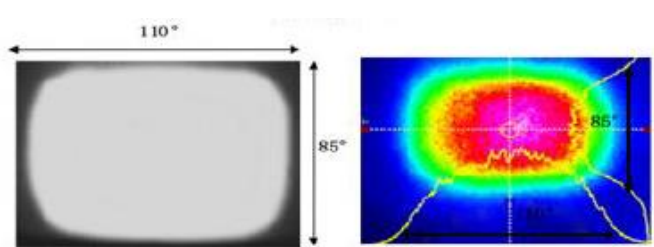

Beam angle: 120°x90°

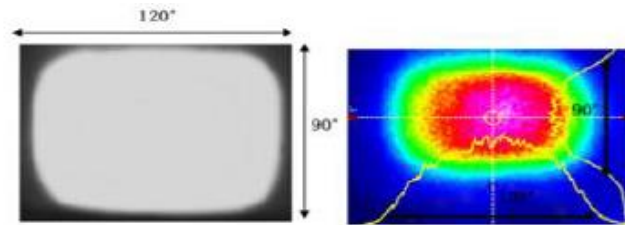

SMT Reflow Soldering Curve

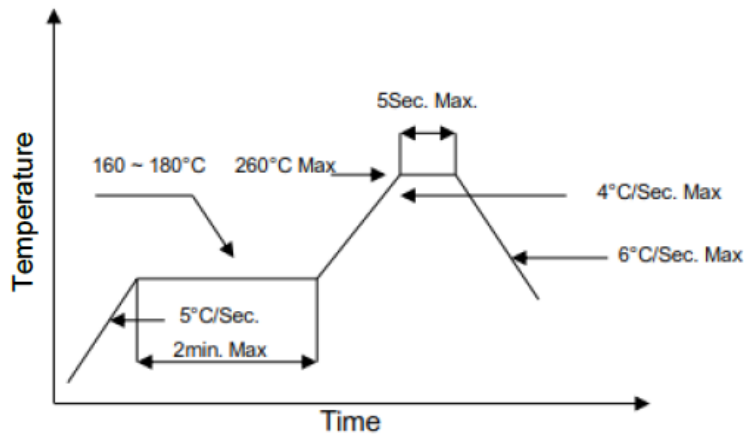

Note: Reflow soldering can be operated only one time. During the temperature ramp-up, no forces may be exerted on the LD which would deform or damage them. After soldering is completed, please do not process until the product temperature ramps down to room temperature.

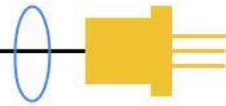

Ordering Information

Part Number	Diffuser Beam Angle
VCD35A-940H1WA	60°x45°
VCD35A-940H1WB	72°x58°
VCD35A-940H1WC	90°x70°
VCD35A-940H1WD	110°x85°
VCD35A-940H1WE	120°x90°

Additional Notes

1. Please use solder paste to cure the laser diode.
2. Please make sure that the heat of VCSEL diode has been completely conducted to metal shell to avoid affecting the optical power output.
3. This VCSEL diode can be only used in constant voltage and current.
4. Please do not aim the laser at people or animals.
5. You may observe the laser spot through an image monitoring equipment.
6. Please do not touch VCSEL diode surface by naked hands or squeeze the sealant on VCSEL diode surface. It may cause wrong optical angle and distorted laser spot, and even damage the VCSEL diode.
7. Please use ceramic suction nozzle to absorb the VCSEL diode, so as to avoid VCSEL diode sticking to the nozzle.
8. Please add a 0.02s blowing action after locating the laser diode to aluminum substrate.
9. Specifications are subject to change without notice.