



940nm 160mW VCSEL with Diffuser in 3535 Package

Model No. VCD35A-940H160x

Features

- 3535 package
- Low wavelength drift
- Oxide isolation technology
- Low threshold current
- Easy to collimate
- 160mW 940nm VCSEL @ 200mA

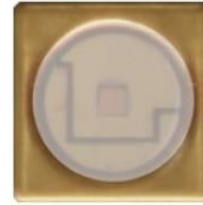

3535 Package with Diffuser

Applications

- 3D sensor
- Gesture recognition
- IR illumination
- Medical application
- Broadband access network

Specifications

Absolute Maximum Ratings				
Parameters	Symbol	Rating	Unit	Conditions
Case Operating Temperature	Top	-40 to 85	°C	
Storage Temperature	Tstg	-40 to 105	°C	
Reflow Soldering Temperature	Tsol	260	°C	10 seconds
Reverse Voltage	Vr	3	V	
Maximum Continuous Current	I _{max}	300	mA	
ESD Exposure (Human Body) Model	ESD	2K	V	

Notes:

- Stresses greater than those listed under “Absolute Maximum Ratings” may cause permanent damage to the device. This is a stress rating only and functional operation of the device at these or other conditions above those indicated in the operations section for expanded periods of time may affect reliability.
- In its maximum rating diode laser operation could damage its performance or cause potential safety hazard such as equipment failure.
- Electrostatic discharge is the main reason for laser fault of the diode. Take effective precautions against ESD. When dealing with laser diodes, use wrist strap, grounding work surface and strict antistatic technology.

Electro-Optical Characteristics (T _{op} =25°C, CW Mode)						
Parameters	Symbol	Min.	Typ.	Max.	Unit	Conditions
Optical Output Power	P _o	-	160	-	mW	I _F =200mA
Threshold Current	I _{th}	-	26	-	mA	
Forward Current	I _F	-	200	-	mA	
Power Conversion Efficiency	η	-	36	-	%	I _F =200mA
Slope Efficiency	SE	-	0.9	-	W/A	I _F =160mA
Peak Wavelength	λ _p	930	940	950	nm	I _F =200mA
Forward Voltage	V _f	-	2.1	-	V	I _F =200mA
Series Resistance	R	-	2.9	-	Ohm	I _F =200mA
Wavelength Temperature Drift	Δλ _p / ΔT	-	-	0.07	nm/°C	I _F =200mA
Beam Divergence (without diffuser)	FWHM _B	-	16	-	deg	
Number of Emission Aperture		-	20	-		
Substrate					AIN	

Note: Electro-optical characteristic with a package or diffuser would require further evaluation. Values are based on limited sample size and estimated values.



Typical Characteristics

LIV Graph

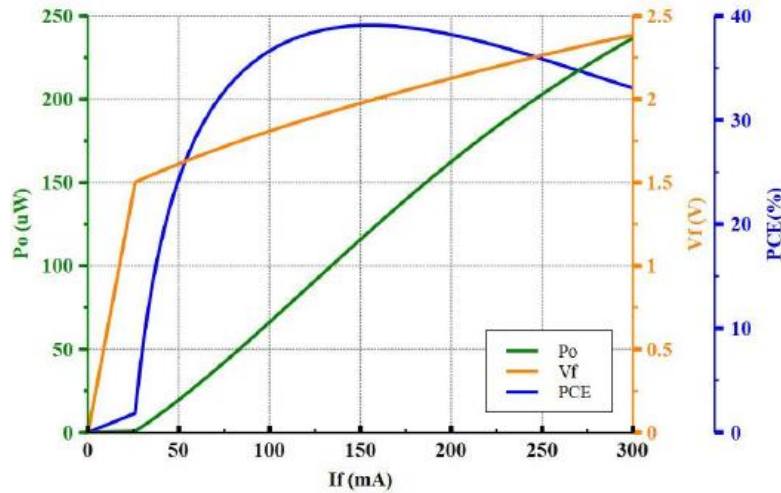

Intensity vs. Wavelength

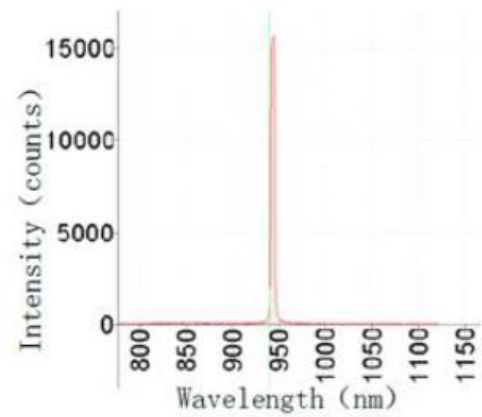

Outline Dimensions (unit: mm)

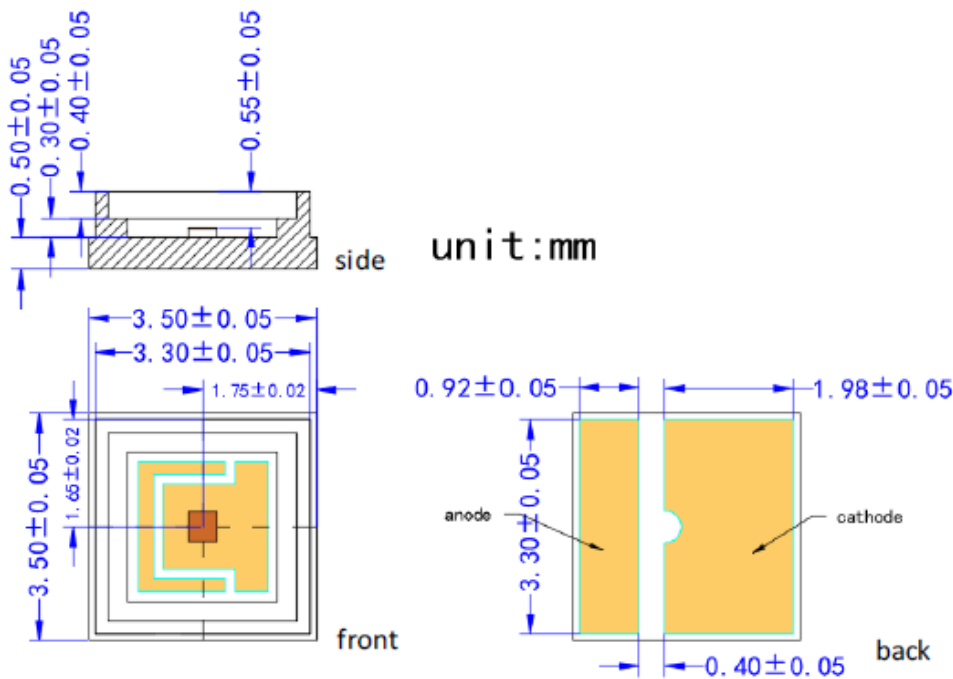

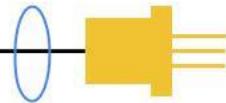

Typical Laser Spot and Beam Profile with Diffuser

Beam angle: 60°x45°

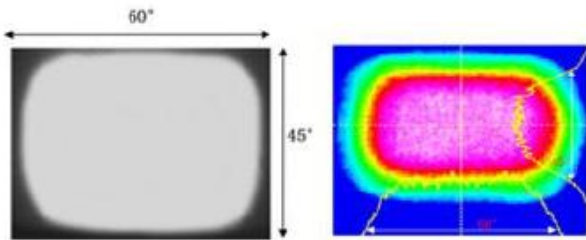

Beam angle: 72°x58°

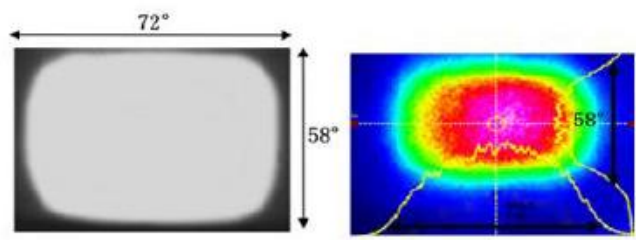

Beam angle: 90°x70°

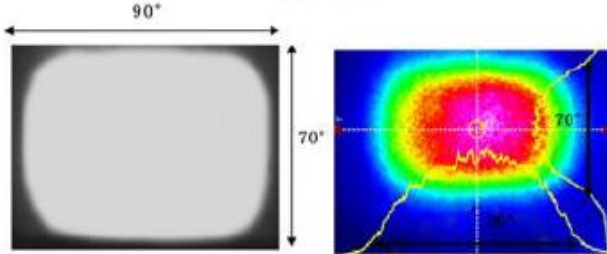

Beam angle: 110°x85°

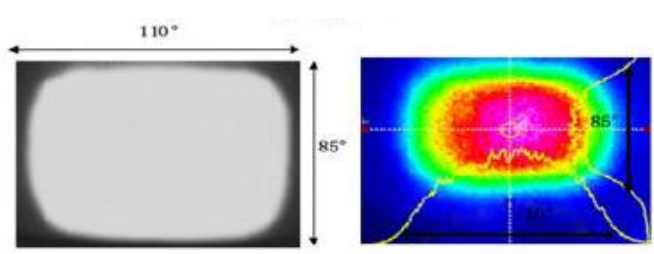

Beam angle: 120°x90°

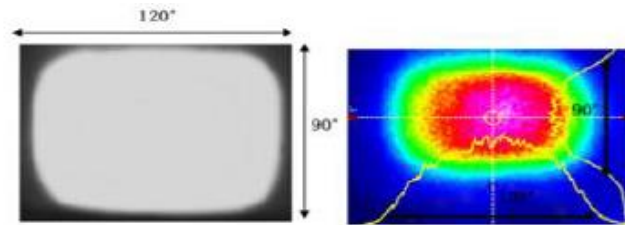

SMT Reflow Soldering Curve

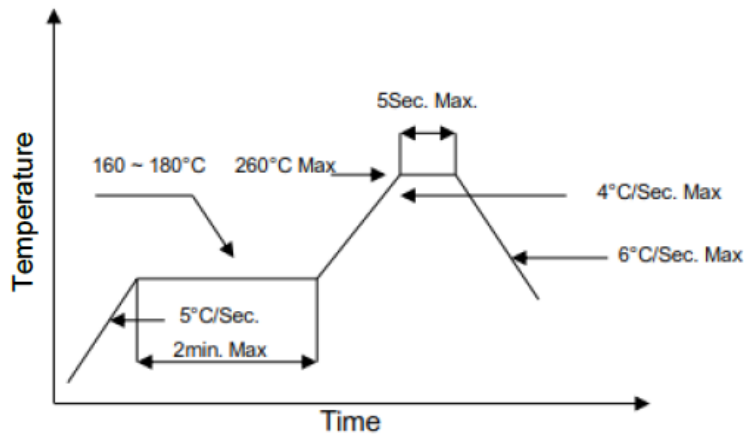

Note: Reflow soldering can be operated only one time. During the temperature ramp-up, no forces may be exerted on the LD which would deform or damage them. After soldering is completed, please do not process until the product temperature ramps down to room temperature.

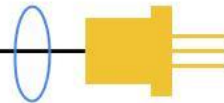

Ordering Information

Part Number	Diffuser Beam Angle
VCD35A-940H160A	60°x45°
VCD35A-940H160B	72°x58°
VCD35A-940H160C	90°x70°
VCD35A-940H160D	110°x85°
VCD35A-940H160E	120°x90°

Additional Notes

1. Please use solder paste to cure the laser diode.
2. Please make sure that the heat of VCSEL diode has been completely conducted to metal shell to avoid affecting the optical power output.
3. This VCSEL diode can be only used in constant voltage and current.
4. Please do not aim the laser at people or animals.
5. You may observe the laser spot through an image monitoring equipment.
6. Please do not touch VCSEL diode surface by naked hands or squeeze the sealant on VCSEL diode surface. It may cause wrong optical angle and distorted laser spot, and even damage the VCSEL diode.
7. Please use ceramic suction nozzle to absorb the VCSEL diode, so as to avoid VCSEL diode sticking to the nozzle.
8. Please add a 0.02s blowing action after locating the laser diode to aluminum substrate.
9. Specifications are subject to change without notice.