



TW652R658 Series 652-658nm Wavelength Tunable Narrow Linewidth Laser System up to 10mW

Overview

The TW652R658 series wavelength tunable diode laser is ideal for applications that require a wavelength range of 652-658nm and output power levels up to 10mW. The laser is a high-end custom high stability, low noise, narrow linewidth, wavelength tunable product with a linewidth of less than 60pm and a tuning range of 4nm. The laser is widely used in scientific research and teaching, such as holographic imaging, Raman, atomic clock, coherent detection, and many other applications.



Specifications

Model Number	TW652R658-XZ	
Wavelength range of roughly tuning (nm)	652-658	
Output power (mW)	>10 (X=10)	
Transverse mode	Near TEM ₀₀	
Operating mode	CW	
Power stability (rms, over 4 hours)	<3% (Z=E), <1% (Z=D)	
Spectral linewidth (nm)	<0.1	
Beam diameter at aperture (1/e ² , mm)	~3.0	
Beam divergence, full angle (mrad)	<1.0	
Polarization ratio	>50:1, Horizontal ±5 degree	
Warm-up time (minutes)	<15	
Beam height from base plate (mm)	45.5	
Operating temperature (°C)	20-30	
Dimensions of laser head (mm)	125(L)×110(W)×67(H) mm ³	
Power supply	Current	0-150mA
	TEC	7-12kΩ
	PZT voltage	0-100V
	Dimensions	299(L)×174(W)×120(H) mm ³
Expected lifetime (hours)	10,000	
Warranty period	10 months	
FDA Compliance	FDA CDRH Title 21 CFR 1040.10/11 Class IIIb	

Remarks:

- Specifications of the CW laser is based on the laser performance at full power output after the specified warmup period. The stability of output power may change when output power is adjusted at a different power level.



Outline Dimensions (unit: mm)

Laser Head

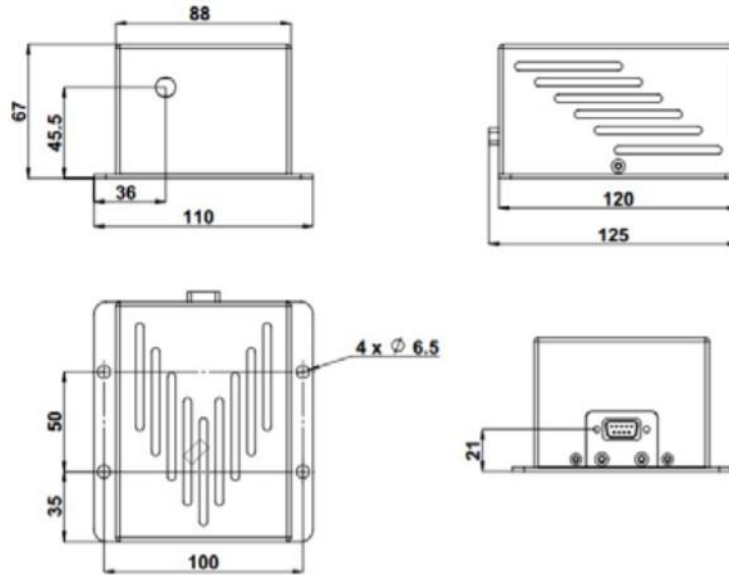

Power Supply

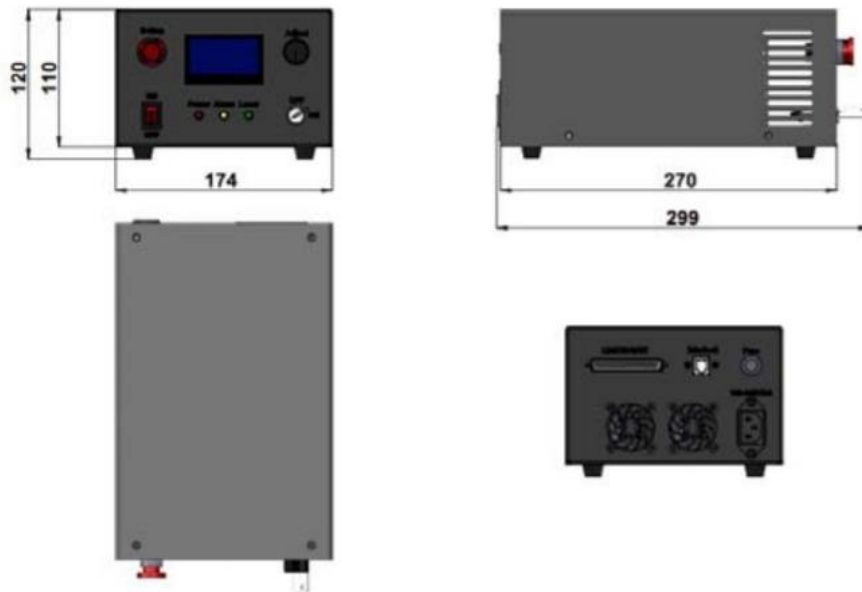

Note: The above specifications are subject to change without notice.