



T78E-XYZ-WM 780nm Fiber Coupled Laser Diodes

With 9/125 μ m SM Fiber and Multimode Beam

	Read Model No.	T78E-XYZ-WM
	T78E = Laser	780 nm laser
	X = Package	Pigtailed with 9/125 μ m SM fiber (X=P)
	Y = Connector	SC/PC (Y=SC), ST/PC (Y=ST), FC/PC (Y=FC)
	Z = Output power	1mW (Z=1), 20mW (Z=20)
	W = Pinout configuration	Common anode (W=2)
	M = Mount	No flange (M=0), Horizontal mount (M=1)

Features

- 780nm laser diode
- Operation at -10°C to +50 °C or -10°C to +70 °C
- Built-in monitor photodiode
- Fiber optical output power >1mW and >20mW for 9/125um SM fiber

Packaging

- Fiber pigtailed with optional FC/SC/ST connector

Applications

- Light source

Specifications

Absolute Maximum Ratings (T _C = 25°C)				
Parameter		Symbol	Rating	Unit
Operating Temperature	For Z=1	T _{op}	-10 to +50	°C
	For Z=20		-10 to +70	
Storage Temperature		T _{stg}	-40 to +85	°C
LD Reverse Voltage		V _{RLD}	2	V
PD Reverse Voltage		V _{RPD}	30	V

Electrical-Optical Characteristics (T _C = 25°C)							
Parameter		Symbol	Min.	Typ.	Max	Unit	Conditions
Lasing Wavelength		λ	770	785	800	nm	
Threshold current	For Z=1	I _{th}	-	25	-	mA	CW
	For Z=20		-	35	-		
Operating current	For Z=1	I _{op}	-	35	-	mA	
	For Z=20		-	90	-		
Operating voltage	For Z=1	V _{op}	-	2.2	2.5	Volt	
	For Z=20		-	2.0	2.2		
Optical output power	For Z=1	P _o	1			mW	9/125 μ m SM fiber
	For Z=20		20				
Monitor current	For Z=1	I _m	50	250	600	μ A	
	For Z=20		100	850	1300		

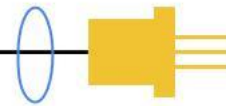

Pin Configuration

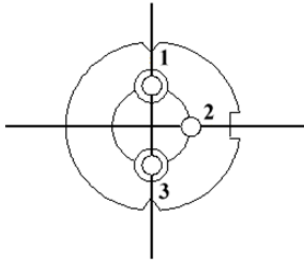

Bottom View

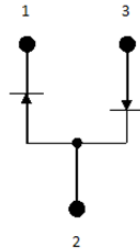

1. Laser diode cathode
2. Laser diode anode
Photodiode cathode
3. Photodiode anode

Mechanical Outline (unit: mm)

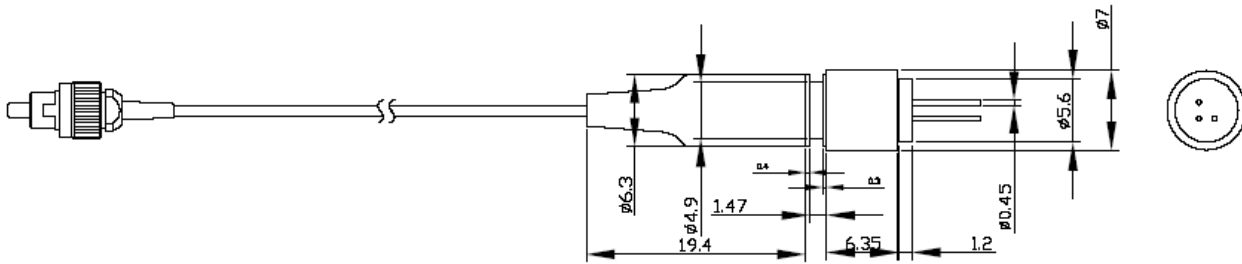

Horizontal Mount

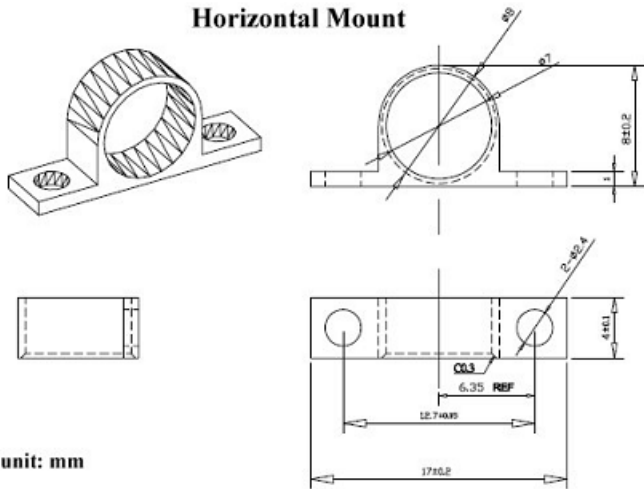

unit: mm

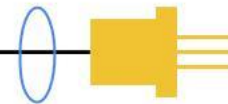

Ordering Information

Part Number	Package	Connector	Output Power	Mount
T78E-PSC1-20	Pigtailed with 9/125um SM fiber	SC/PC	1mW	No flange
T78E-PST1-20	Pigtailed with 9/125um SM fiber	ST/PC	1mW	No flange
T78E-PFC1-20	Pigtailed with 9/125um SM fiber	FC/PC	1mW	No flange
T78E-PSC1-21	Pigtailed with 9/125um SM fiber	SC/PC	1mW	Horizontal mount
T78E-PST1-21	Pigtailed with 9/125um SM fiber	ST/PC	1mW	Horizontal mount
T78E-PFC1-21	Pigtailed with 9/125um SM fiber	FC/PC	1mW	Horizontal mount
T78E-PSC20-20	Pigtailed with 9/125um SM fiber	SC/PC	20mW	No flange
T78E-PST20-20	Pigtailed with 9/125um SM fiber	ST/PC	20mW	No flange
T78E-PFC20-20	Pigtailed with 9/125um SM fiber	FC/PC	20mW	No flange
T78E-PSC20-21	Pigtailed with 9/125um SM fiber	SC/PC	20mW	Horizontal mount
T78E-PST20-21	Pigtailed with 9/125um SM fiber	ST/PC	20mW	Horizontal mount
T78E-PFC20-21	Pigtailed with 9/125um SM fiber	FC/PC	20mW	Horizontal mount

Additional Notes

- The laser diodes are designated solely as OEM components for incorporation into the customer's end products. Therefore, it is the customer's responsibility to comply with the appropriate requirements of FDA 21CFR, section 1040.10 and 1040.11 for complete laser products. For the code of FDA regulations, please refer to [FDA Performance Standards for Light-Emitting Products](#) for detailed information.
- Specifications are subject to change without notice.