

T63E-XYZ-WM 635nm Fiber Coupled Laser Diodes

With 9/125 μ m SM Fiber and Multimode Beam

	Read Model No.	T63E-XYZ-WM
	T63E = Laser	635 nm laser
	X = Package	Pigtailed with 9/125 μ m SM fiber (X=P)
	Y = Connector	SC/PC (Y=SC), ST/PC (Y=ST), FC/PC (Y=FC)
	Z = Output power	1mW (Z=1), 2mW (Z=2)
	W = Pinout configuration	Common anode (W=2)
	M = Mount	No flange (M=0), Horizontal mount (M=1)

Features

- 635nm laser diode
- Operation at -10°C to +50 °C
- Built-in monitor photodiode
- Fiber optical output power >1mW and >2mW for 9/125um SM fiber

Packaging

- Fiber pigtailed with optional FC/SC/ST connector

Applications

- Design for optical fiber checker
- Light source

Specifications

Absolute Maximum Ratings ($T_c = 25^\circ\text{C}$)			
Parameter	Symbol	Rating	Unit
Operating Temperature	T_{op}	-10 to +50	°C
Storage Temperature	T_{stg}	-40 to +85	°C
LD Reverse Voltage	V_{RLD}	2	V
PD Reverse Voltage	V_{RPD}	30	V

Electrical-Optical Characteristics ($T_c = 25^\circ\text{C}$)							
Parameter	Symbol	Min.	Typ.	Max	Unit	Conditions	
Lasing Wavelength	λ	625	635	645	nm		
Threshold current	For Z=1	I_{th}	-	26	40	mA	CW
	For Z=2		-	35	-		
Operating current	For Z=1	I_{op}	-	30	-	mA	
	For Z=2		-	50	-		
Operating voltage	V_{op}	-	2.0	2.5	Volt		
Optical output power	For Z=1	P_o	1			mW	9/125 μ m SM fiber
	For Z=2		2				
Monitor current	I_m	50	110	500	μ A		

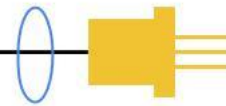

Pin Configuration

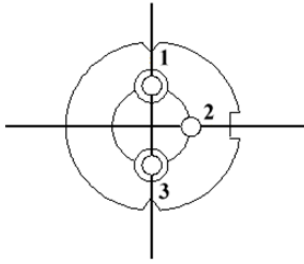

Bottom View

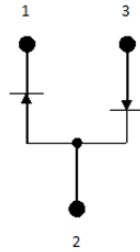

- 1. Laser diode cathode
- 2. Laser diode anode
Photodiode cathode
- 3. Photodiode anode

Mechanical Outline (unit: mm)

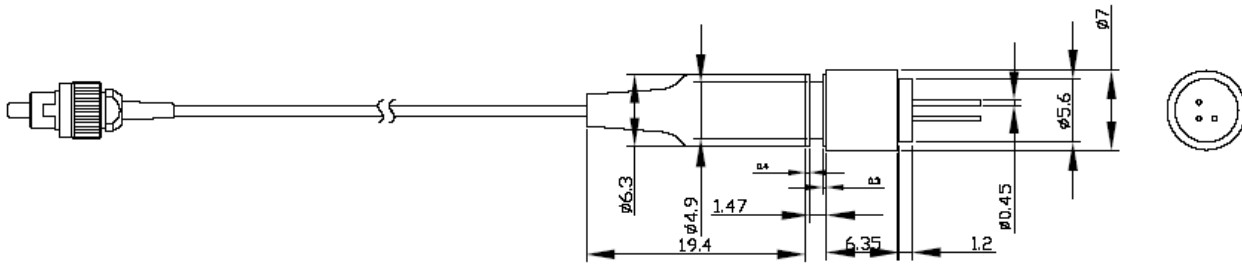

Horizontal Mount

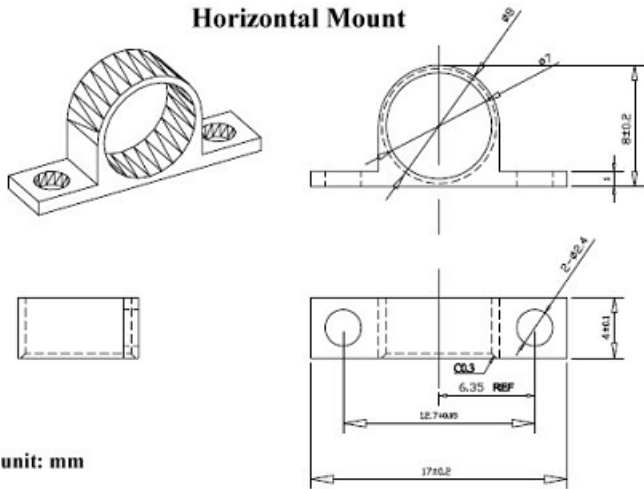

unit: mm

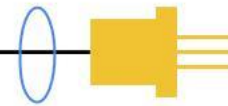

Ordering Information

Part Number	Package	Connector	Output Power	Mount
T63E-PSC1-20	Pigtailed with 9/125um SM fiber	SC/PC	1mW	No flange
T63E-PST1-20	Pigtailed with 9/125um SM fiber	ST/PC	1mW	No flange
T63E-PFC1-20	Pigtailed with 9/125um SM fiber	FC/PC	1mW	No flange
T63E-PSC1-21	Pigtailed with 9/125um SM fiber	SC/PC	1mW	Horizontal mount
T63E-PST1-21	Pigtailed with 9/125um SM fiber	ST/PC	1mW	Horizontal mount
T63E-PFC1-21	Pigtailed with 9/125um SM fiber	FC/PC	1mW	Horizontal mount
T63E-PSC2-20	Pigtailed with 9/125um SM fiber	SC/PC	2mW	No flange
T63E-PST2-20	Pigtailed with 9/125um SM fiber	ST/PC	2mW	No flange
T63E-PFC2-20	Pigtailed with 9/125um SM fiber	FC/PC	2mW	No flange
T63E-PSC2-21	Pigtailed with 9/125um SM fiber	SC/PC	2mW	Horizontal mount
T63E-PST2-21	Pigtailed with 9/125um SM fiber	ST/PC	2mW	Horizontal mount
T63E-PFC2-21	Pigtailed with 9/125um SM fiber	FC/PC	2mW	Horizontal mount

Additional Notes

- The laser diodes are designated solely as OEM components for incorporation into the customer's end products. Therefore, it is the customer's responsibility to comply with the appropriate requirements of FDA 21CFR, section 1040.10 and 1040.11 for complete laser products. For the code of FDA regulations, please refer to [FDA Performance Standards for Light-Emitting Products](#) for detailed information.
- Specifications are subject to change without notice.