



1550nm DFB Laser Diode TOSA

Model No. T15D-XYZ-WM-TI-D

Read Model No.	T15D-XYZ-WM-TI-D
T15D = Laser	1550nm DFB laser
X = Package	Pigtailed with 9/125um SM fiber (X=P); Receptacle (X=R)
Y = Connector	None (Y=NO); FC/PC (Y=FC); SC/PC (Y=SC); ST/PC (Y=ST); LC/PC (Y=LC); FC/APC (Y=FA); SC/APC (Y=CA); ST/APC (Y=TA)
Z = Output power	>0.5mW (Z=M); >1mW (Z=H); >2mW (Z=2)
W = Pin configuration	A pinout (W=A); C pinout (W=C)
M = Mount	For Receptacle: (M=R) For Pigtail: No flange (M=0); Horizontal mount (M=1)
T = Operating temperature	-40 to 85°C (T=4)
I = Isolator	Without isolator (I=N); With isolator (I=I)
D = Data rate	1.25Gbps (D=1G); 2.5Gbps (D=2G)

Features

- 1550nm InGaAsP/InP MQW-DFB laser diode (LD)
- Data Rate: 155Mbps up to 2.5Gbps
- Uncooled operation at -40 to 85°C
- Hermetically sealed active component
- High performance, high speed InGaAs monitor PIN photodiode (PD)
- Based on Telcordia reliability
- Optional with single-stage isolator



Packaging

- Single-mode Fiber pigtailed with optional FC/ST/SC/LC connector
- FC/ST/SC receptacle package with 2-hole flange



Applications

- ATM/SONET OC-3/OC-12/OC-24/OC-48
- SDH STM-1/STM-4/STM-8, ITU-T recommendations
- Stable emitting source at specific wavelength



Specifications

Absolute Maximum Ratings				
Parameters	Symbol	Value	Unit	Conditions
Storage temperature	Tstg	-40 to +85	°C	
Operating case temperature	Top	-40 to +85	°C	
Peak optical output power	Po	5	mW	
Forward current (LD)	I _{FLD}	100	mA	
Reverse voltage (LD)	V _{RLD}	2	V	
Reverse current (PD)	I _{RPD}	5	mA	
Reverse voltage (PD)	V _{RPD}	15	V	
Soldering temperature	Stemp	260	°C	10 seconds

Electro-Optical Characteristics (CW @ T _c = 25°C unless otherwise noted)						
Parameters	Symbol	Min.	Typ.	Max.	Unit	Conditions
Central wavelength	λ_c	1540	1550	1560	nm	CW, Pf
Side mode suppression ratio	SMSR	30	40	-	dB	Pf
Spectral width	$\Delta\lambda$	-	0.2	1	nm	Pf
Threshold current	I _{th}	-	10	15	mA	CW
Fiber output power	Pf	0.5			mW	CW, I _f =I _{th} +20mA
		1.0				
		2.0				
Operating voltage	V _{op}	-	1.1	1.5	V	Pf
Rise time / Fall time	t _r /t _f	-	0.1	0.2	nsec	I _b = I _{th} , 20%~80%
Monitor current	I _m	100	-	1000	uA	Pf, V _{rp} =5V
Monitor dark current	I _d	-	0.1	100	nA	V _{rp} =5V
Monitor capacitance	C	-	10	20	pF	V _{rp} =5V, f=1MHz
Tracking error*	Δ Pf/ Pf	-	±1.0	±1.5	dB	APC, T _c =-40~+85°C

*I_m=constant @ Pf, T_c=25 °C

Fiber Pigtail Specifications					
Parameters	Symbol	Min.	Typ.	Max.	Unit
Fiber type		Single Mode Fiber (Flame Retardant Hytrel Coating)			
Cladding diameter	D _{cl}	122	125	128	um
Mode field diameter	D _{mf}	-	10	-	um
Coating diameter	D _{bc}	-	0.9	1	mm
Pigtail length*	L	0.9	1.0	1.1	m
Bending radius	R _b	30	-	-	mm
Connector		TBD			

*From the ferrule-end to the bottom of TO-header.

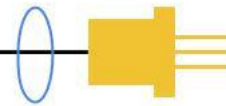

Outline Dimensions (unit: mm)

Pigtail:

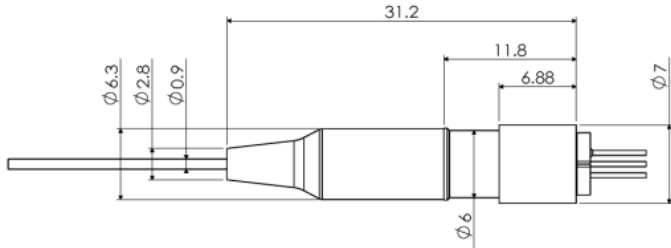

P.C.D. 2.0 ± 0.5

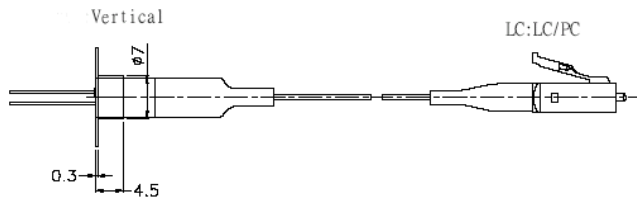
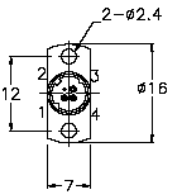
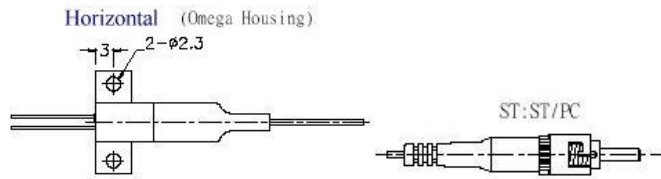
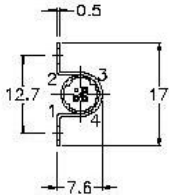
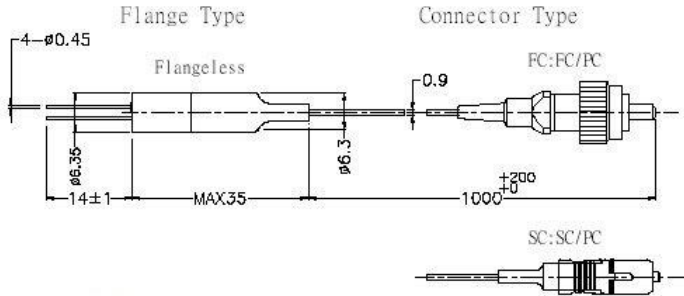

Horizontal Mount:

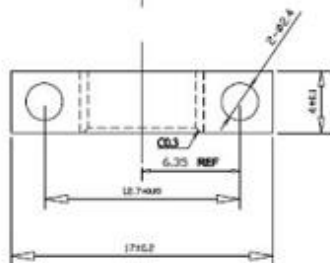
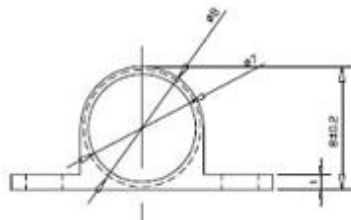
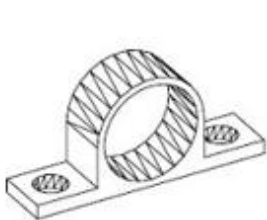

unit: mm

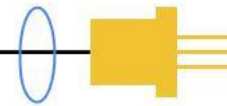

Receptacle:

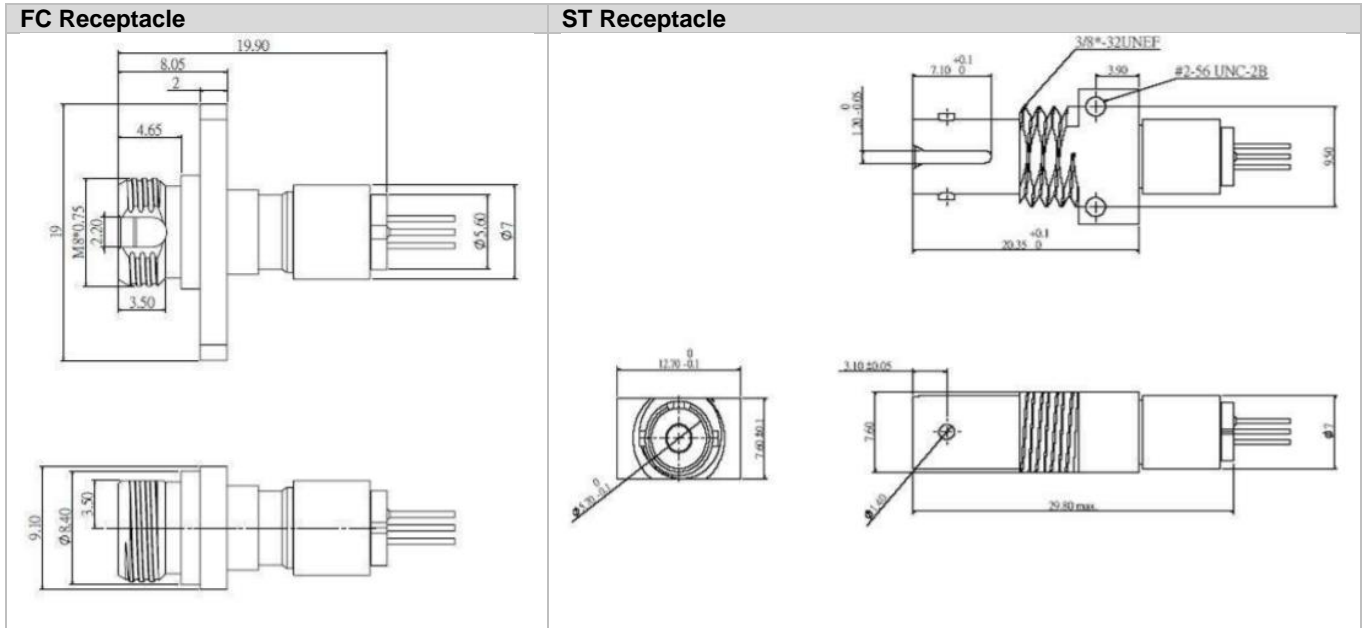

Pin Assignment

Bottom View

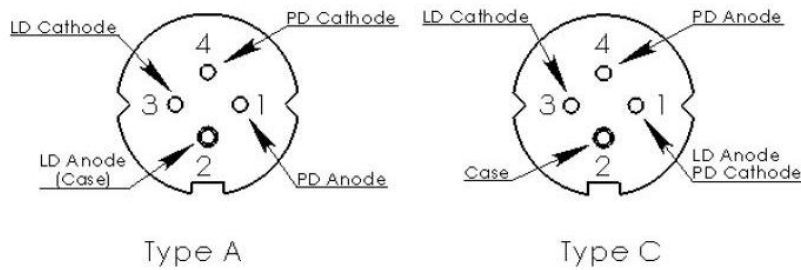

Pin Number	Type A	Type C
1	PD Anode	LD Anode, PD Cathode
2	LD Anode (case)	Case
3	LD Cathode	LD Cathode
4	PD Cathode	PD Cathode

Note: Specifications are subject to change without notice.