

RAM830 Series 830nm Fiber Coupled Narrow Linewidth Laser for Raman Spectroscopy

Overview

The RAM830 series fiber coupled diode laser is ideal for applications that require a wavelength of 830nm and output power levels up to 100mW. Designed specifically for Raman spectroscopy and with features of narrow spectral bandwidth, spectral purity and a high level of wavelength stability, the laser has integrated laser driver and thermoelectric cooler. Its compact dimensions and convenient functions make the laser optimal for industrial and medical applications.



Specifications

Model Number	RAM830-XPY	
Central wavelength (nm)	830±0.5	
Operating mode	CW	
Fiber core diameter	100um, 0.22 NA	
Fiber connector	SMA905	
Output power after fiber (mW)	>10 (X=10), >20 (X=20), >50 (X=50), >100 (X=100)	
Power stability (rms, over 4 hours)	<3% (P=E), <2% (P=2), <1% (P=D)	
Spectral linewidth (nm)	0.1 (Y=L), 0.06 (Y=M)	
Central wavelength stability (rms, over 2 hours) (pm)	<10	
Noise of amplitude (rms, 1-20MHz)	<1%	
Warm-up time (minutes)	<5	
Operating temperature (°C)	20-30	
Dimensions of laser (mm)	169(L)×115(W) ×52(H) mm ³	
Weight of laser (kg)	1.0 kg	
Laser power consumption	5VDC@5A	
Accessory (Adaptor)	Input voltage	85-264VAC
	Dimensions	120(L)×60(W) ×37(H) mm ³
	Weight	0.3 kg
Expected lifetime (hours)	10,000	
Warranty period	10 months	
FDA Compliance	FDA CDRH Title 21 CFR 1040.10/11 Class IIIb	

Remarks:

- Specifications of the CW laser is based on the laser performance at full power output after the specified warmup period. The stability of output power may change when output power is adjusted at a different power level.



Outline Dimensions (unit: mm)

Laser

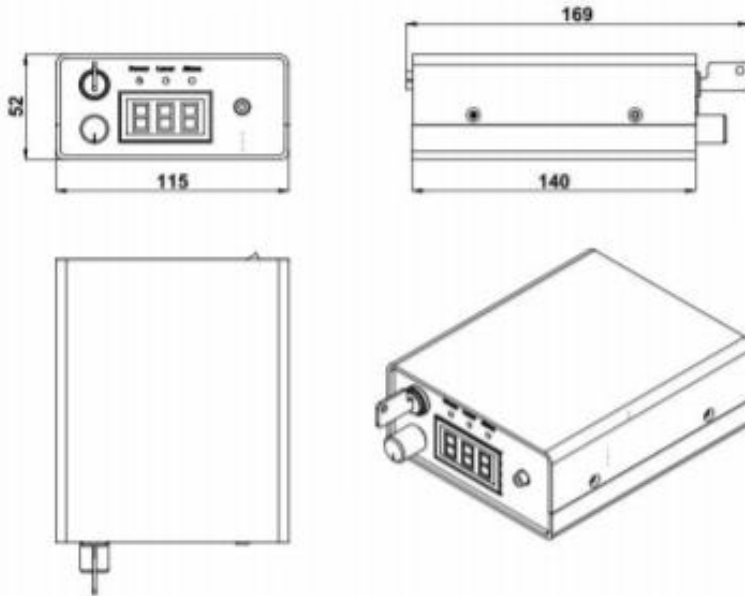

Accessories

Adaptor

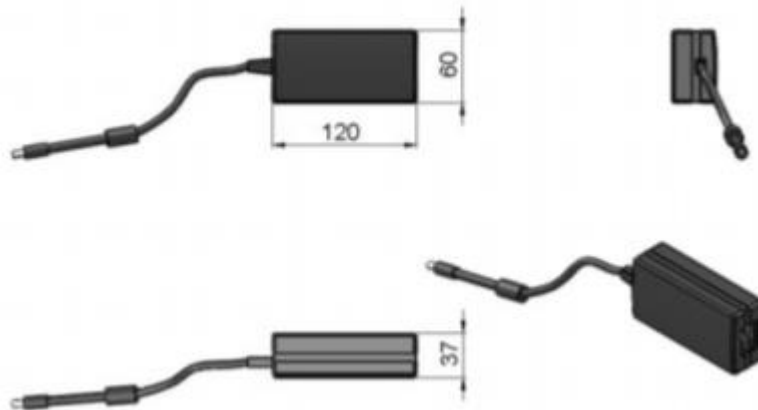

Note: The above specifications are subject to change without notice.