

2.5GHz 1310nm/1550nm Analog InGaAs PIN Photodiode in TO-46 Package, 4-pin

Part No. PDA-A13A4-2G

Features

- InGaAs PIN PD 4 pin TO for Analog application
- Industry standard TO-46 package with 1550nm AR coating cap lens and tab-less
- High responsivity at long wavelength
- Low inter-modulation distortion
- Suitable for CATV application



Specifications

Electro-Optical Characteristics (Typical values are at 25°C)						
Parameters	Symbol	Min.	Typ.	Max.	Unit	Conditions
Responsivity	R	0.8	0.9		A/W	$\lambda=1310\text{nm}$, $V_R=5\text{V}$
		0.9	1			$\lambda=1550\text{nm}$, $V_R=5\text{V}$
Dark Current	I_D		0.1	1	nA	$V_R=5\text{V}$, $T_A=25^\circ\text{C}$
Breakdown Voltage	V_{BD}	25	50		V	$I_R=10\mu\text{A}$
Second Order Inter-Modulation Distortion	IMD2		-75	-70	dBc	$\lambda=1550\text{nm}$ ⁽¹⁾
Third Order Inter-Modulation Distortion	IMD3		-85	-80	dBc	$\lambda=1550\text{nm}$ ⁽²⁾
Capacitance	C		0.56	0.7	pF	$V_R=5\text{V}$, $f=1\text{MHz}$
Bandwidth	BW	2.5	3.2			$V_R=5\text{V}$

- (1) IMD2 measured at $V_R = 12\text{V}$, $P_{\text{avg}} = 0\text{dBm}$, $\text{OMI} = 0.7$, $R_{\text{load}} = 50\Omega$, $f_1+f_2 = 850\text{MHz}$, $f_1-f_2 = 50\text{MHz}$. All are measured at 25°C.
- (2) IMD3 measured at $V_R = 12\text{V}$, $P_{\text{avg}} = 0\text{dBm}$, $\text{OMI} = 0.7$, $R_{\text{load}} = 50\Omega$, $f_1+f_2 = 500\text{MHz}$, $f_1-f_2 = 350\text{MHz}$. All are measured at 25°C.

Absolute Maximum Ratings				
Parameters	Min.	Max.	Unit	Conditions
Storage Temperature	-40	125	°C	
Operating Temperature	-40	85	°C	
Lead Solder Temperature		260	°C	10 seconds
Forward Current		10	mA	
Reverse Voltage		20	V	

Outline Dimensions (unit: mm)

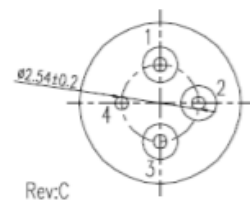
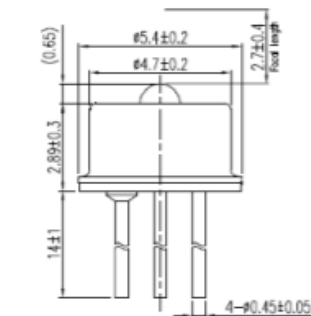

- Pinout:**
1. Cathode
 2. Anode
 3. Case
 4. Case

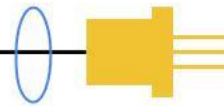

Typical Characteristics

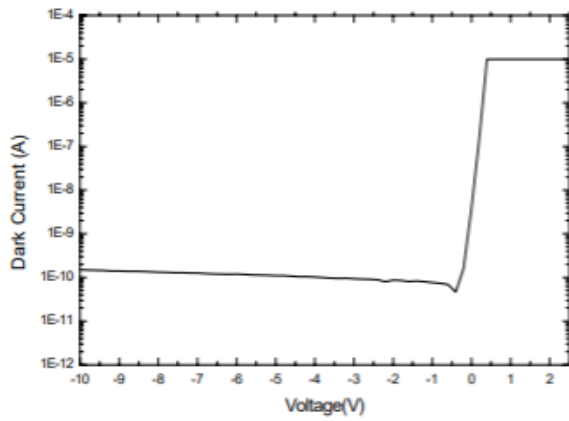

Fig. 1 Typical Dark Current and Forward Current.

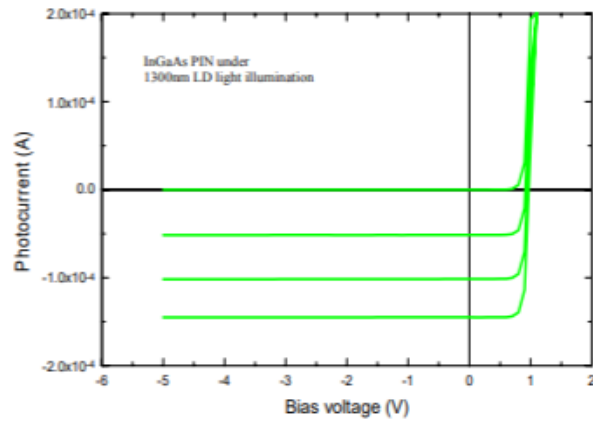

Fig. 2 Typical Photo-Current

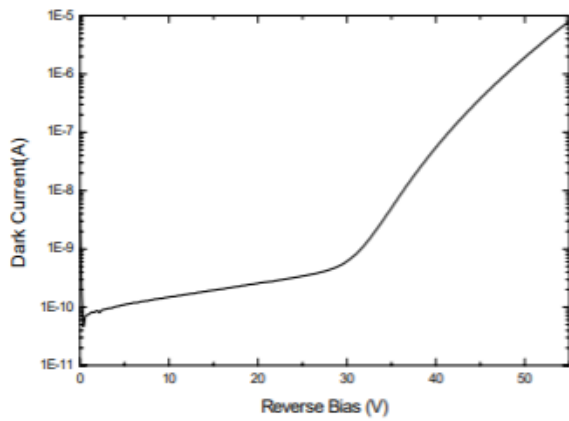

Fig. 3 Typical Breakdown Curve.

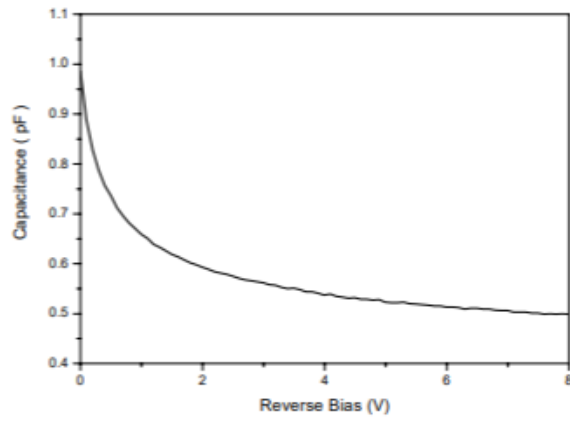

Fig. 4 Typical C-V Curve

Note: Specifications are subject to change without notice.