



940nm Fiber Coupled Infrared LED

Model No. LED940-AM-Q

Overview

The LED940 series fiber coupled LED is ideal for applications that require a wavelength of 940nm. The LED features stable output intensity, long operating lifetime and high power. The LED is widely used in spectroscopy, optogenetics, fluorescence excitation, and many other applications.



Specifications

Model Number	LED940-AM-Q
Nominal wavelength (nm)	940
Color	Infrared
Bandwidth FWHM (nm)	37
Fiber connector	SMA905
Numerical aperture (NA)	0.22
Fiber core diameter	600um
Typical $\phi 600\mu\text{m}$ core fiber output power SMA (mW)	3.0
Maximum current CW (mA)	1000
Forward voltage (V)	2.75
Output power stability (rms, over 4 hours)	<5%
Dimensions of LED head	64 (L) x46.5 (W) x30 (H) mm ³
Weight of LED head	0.2kg
Input Voltage	5V DC
Dimensions of Power supply	114 (L) x78 (W) x71 (H) mm ³
Weight of Power supply	0.3kg
Operating mode	CW (Q=C); CW with TTL modulation: 1Hz-1kHz (Q=T1), 1kHz-10kHz (Q=T2); CW with Analog modulation: 1Hz-1kHz (Q=A1), 1kHz-10kHz (Q=A2)
Operating temperature (°C)	10 to 35 °C
Typical lifetime (h)	~10,000

Remarks:

- The above testing data are only for reference. The actual spectrum of LED may change since the temperature or other parameters are different when operating the current.
- Other core diameter fibers may be available on request.
- Specifications are subject to change without notice.



Outline Dimensions (unit: mm)

LED Head

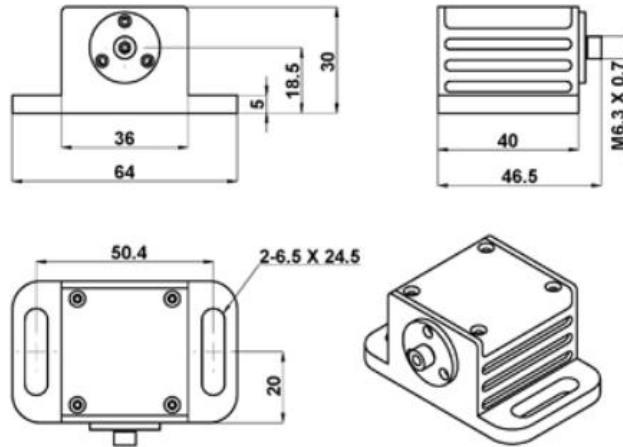

Power Supply

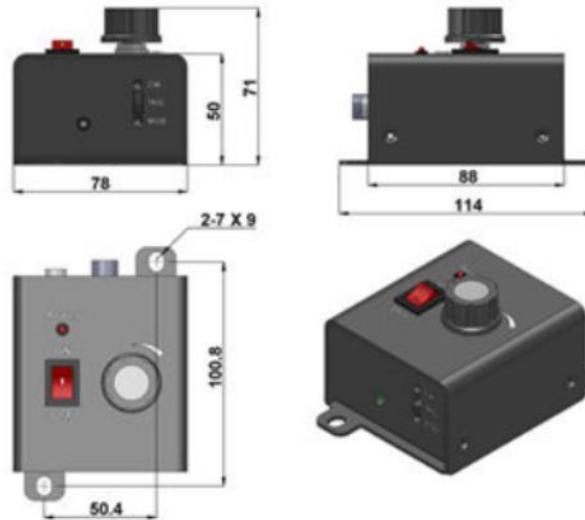

Note: The above specifications are subject to change without notice.