



## LDLC642 Series 642nm Long Coherence Diode Laser System up to 30mW

### Overview

The LDLC642 series diode laser is ideal for applications that require a wavelength of 642nm and output power levels up to 30mW. The laser features narrow spectral linewidth, stable wavelength, ultra-compact design, long operating lifetime, easy operation and FDA-compliant system with driver. The laser is widely used in holography, interference, fluorescence, photoetching, flow cytometry, DNA sequencing, Raman spectroscopy, laser radar, precision measurement, and many other applications.



### Specifications

<b>Model Number</b>	<b>LDLC642-XYP</b>	
Wavelength (nm)	642±5	
Output power (mW)	>10 ( <b>X=10</b> ), >30 ( <b>X=30</b> )	
Transverse mode	Near TEM <sub>00</sub>	
Operating mode	CW	
Power stability (rms, over 4 hours)	<5% ( <b>P=A</b> ), <3% ( <b>P=E</b> ), <1% ( <b>P=D</b> )	
Coherent length (m)	>1	
M <sup>2</sup> factor	<1.5	
Beam diameter at aperture (1/e <sup>2</sup> , mm)	~3.0	
Beam divergence, full angle (mrad)	<1.0	
Polarization ratio	>50:1, Horizontal ±5 degree	
Warm-up time (minutes)	<5	
Beam height from base plate (mm)	30	
Operating temperature (°C)	20-30	
Dimensions of laser head (mm)	122.5(L)×65(W) ×50(H) mm <sup>3</sup>	
Weight of laser head (kg)	1.0 kg	
Power supply		
Elite Power Supply ( <b>Y=E</b> )	Input voltage	85-264VAC
	Dimensions	171(L) ×130(W) ×62.2(H) mm <sup>3</sup>
	Weight	1.2 kg
	Notes	Fixed output power
Expected lifetime (hours)	10,000	
Warranty period	10 months	
FDA Compliance	FDA CDRH Title 21 CFR 1040.10/11 Class IIIb	

#### Remarks:

- Specifications of the CW laser is based on the laser performance at full power output after the specified warmup period. The stability of output power may change when output power is adjusted at a different power level.



**Outline Dimensions (unit: mm)**

**Laser Head**

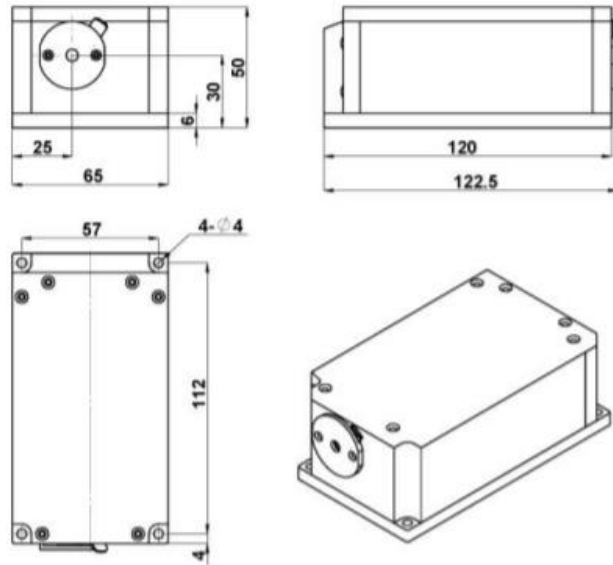

**Power Supply**

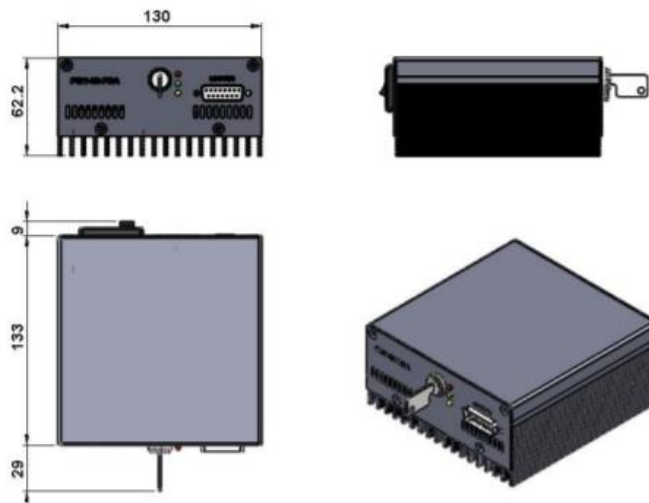

Note: The above specifications are subject to change without notice.