

808nm 60W High Power CW Micro-Channel Water-Cooled Packaged Laser Bar

Part No. LDB808C60WI

OVERVIEW

The LDB-series high power packaged bars provide OEM customers with scalable power up to kilowatts for pumping, industrial and medical applications. The packaged laser bars can be configured for enhanced brightness through stacking, scaled linearly or vertically for optimized light and material integration.

FEATURES

- 808nm Microchannel Water-cooled Packaged Bar
- CW Operation Mode
- High output power: 60W
- High brightness
- Modular and compact design for ease of integration
- Packaged 10mm laser diode bar



SPECIFICATIONS (T_c = 25°C)

Item	Parameter	LDB808C60WI	Unit
Optical Parameter	Center wavelength	808	nm
	Operation mode	CW	-
	Output power	60	W
	Spectral width	<5	nm
	Wavelength Temperature coefficient	0.28	nm/°C
	Fast axis divergence	<39	deg
	Slow axis divergence	<10	deg
Electrical Parameter	Threshold current	<15	A
	Operating current	<70	A
	Operating voltage	<2.0	V
Thermal Parameter	Max. Inlet pressure	65	psi
	Cooling rate	≥0.3	l/min
	Cooling medium particle size	≤15	μm
	Cooling medium conductivity	5 to 10	μs/cm
	Operating temperature	15 to 35	°C
	Storage temperature	-10 to +60	°C

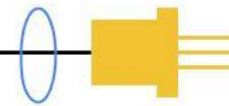

MECHANICAL OUTLINE (unit: mm)

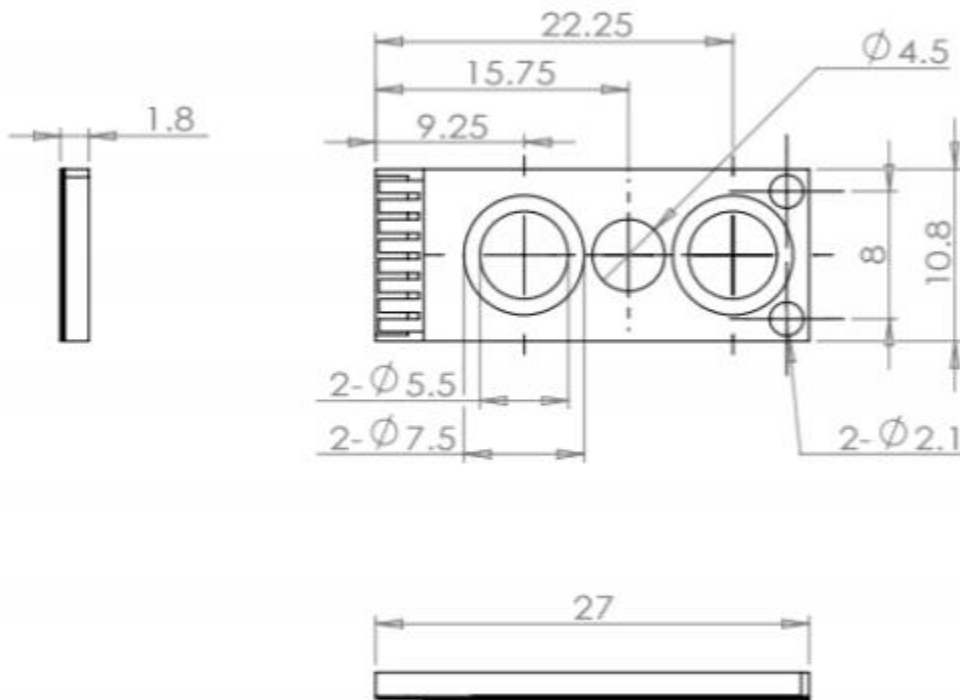

Notes:

1. The above specifications are subject to change without notice.
2. Please make sure that the laser diode is operated under the temperature between 15 °C and 35 °C, as high temperature will increase threshold current, decrease exchange rate and accelerate the aging.
3. Please take measures to avoid condensation, which will cause aging of laser diode.