

980nm 3000mW 30°C Laser Diode in C-Mount Package

Part No. LD980E3WG13

FEATURES

- 980nm 3W Fabry-Perot cavity semiconductor laser
- High power
- Package: C-Mount

SPECIFICATIONS (T_c = 20°C)

Item	Parameter	Typ.	Unit
Optical Parameter	Lasing wavelength	980±10	nm
	Output power	3	W
	Spectral width	≤3	nm
	Emitting area width	150	um
	Temperature coefficient	0.30	nm/°C
	Fast axis divergence	<40	deg
	Slow axis divergence	<10	deg
Electrical Parameter	Slope efficiency	≥1.0	W/A
	Threshold current	≤0.75	A
	Operating current	≤3.6	A
	Operating voltage	≤2.0	V
Others	Package	C-Mount	-
	Operating temperature	15 to 30	°C
	Storage temperature	-40 to +60	°C
	Welding temperature	≤260	°C

TYPICAL CHARACTERISTICS

P-I-V Curve

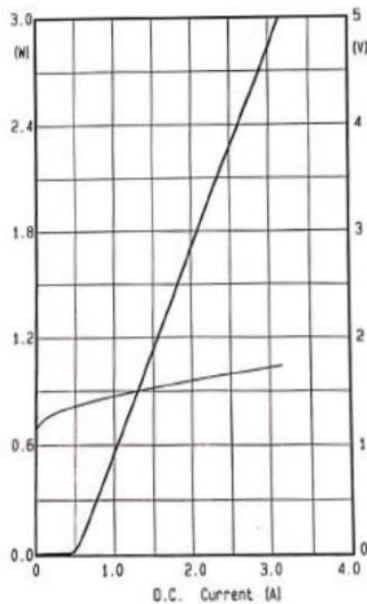

Spectral Curve

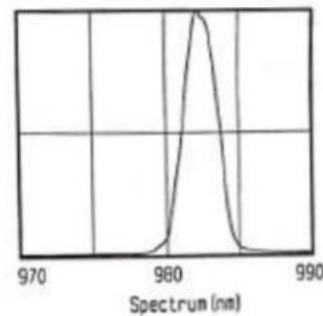

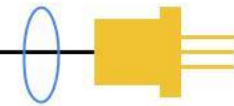

MECHANICAL OUTLINE (unit: mm)

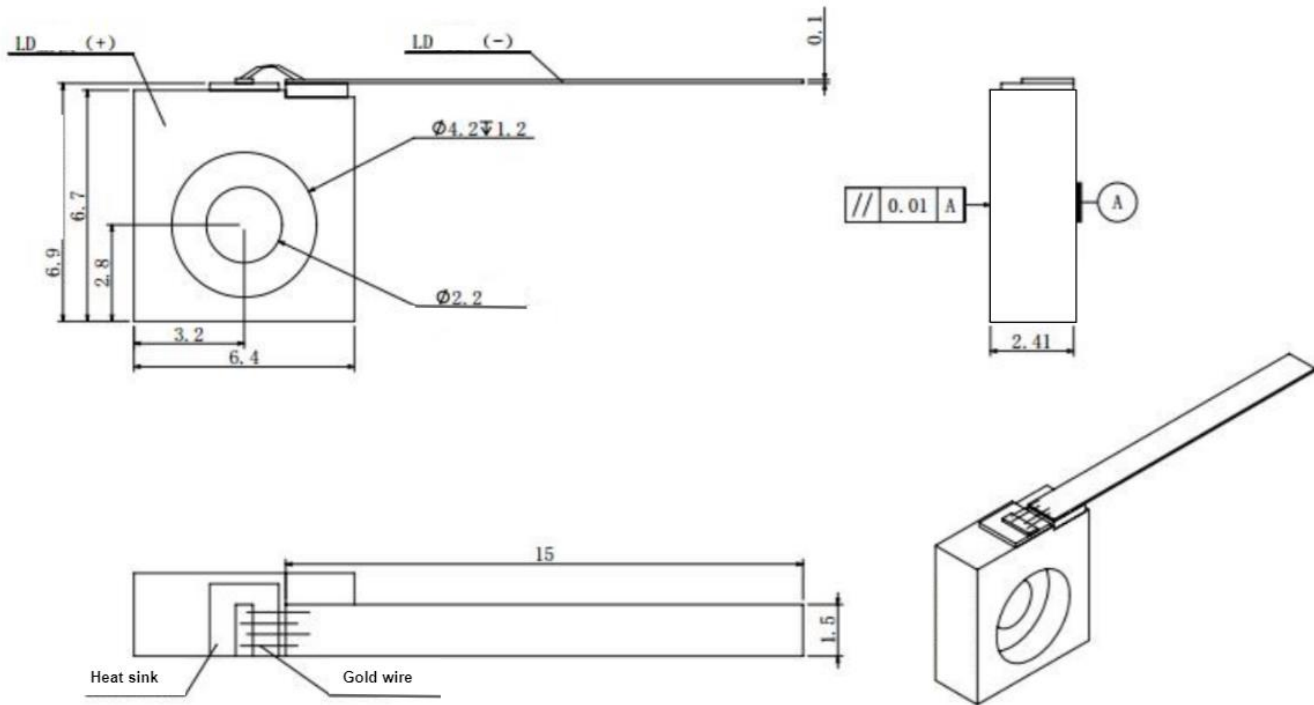

ADDITIONAL NOTES

- Data in the sheet are based on C-mount package heat sink testing.
- Do not operate the device above maximum ratings. Doing so may cause unexpected and permanent damage to the device.
- Take precautions to avoid electrostatic discharge and/or momentary power spikes. A change in the characteristics of the laser or premature failure may result.
- Proper heat sinking of the device assures stability and lifetime. Always ensure that maximum operating temperatures are not exceeded.
- Observing visible or invisible laser beams with human eye directly, or indirectly, can cause permanent damage. Use a camera to observe the laser.
- No laser device should be used in any application or situation where life or property is at risk in the event of device failure.
- Specifications are subject to change without notice. Ensure that you have the latest specification by contacting us prior to purchase or use of the product.