

980nm 500mW 50°C Laser Diode in TO-9 ϕ 9.0mm Package

Part No. LD980A500D15

FEATURES

- 980nm 500mW Fabry-Perot cavity semiconductor laser
- High power
- Package: TO9 (dia. 9.0mm)

SPECIFICATIONS ($T_C = 20^\circ\text{C}$)

Item	Parameter	Min.	Typ.	Max.	Unit
Optical Parameter	Lasing wavelength	970	980	990	nm
	Output power	-	500	-	mW
	Spectral width	-	1.2	2.5	nm
	Emitting area width	-	50	-	um
	Temperature coefficient	-	0.30	-	nm/ $^\circ\text{C}$
	Fast axis divergence	-	34	38	deg
	Slow axis divergence	-	7	10	deg
Electrical Parameter	Slope efficiency	0.9	-	-	W/A
	Threshold current	-	0.11	0.15	A
	Operating current	-	0.59	0.70	A
	Operating voltage	-	1.65	2.00	V
Others	Package	TO-9			-
	Operating temperature	10 to 50			$^\circ\text{C}$
	Storage temperature	-10 to +60			$^\circ\text{C}$

TYPICAL CHARACTERISTICS

P-I-V Curve

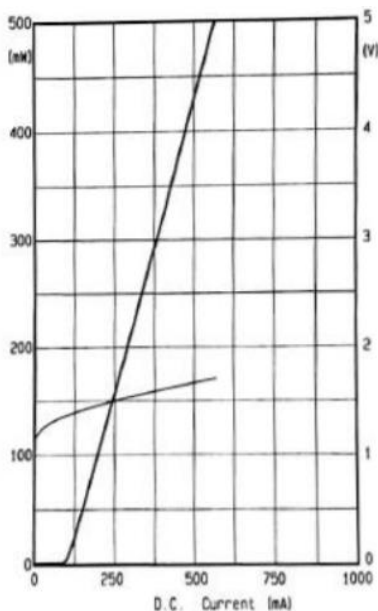

Spectral Curve

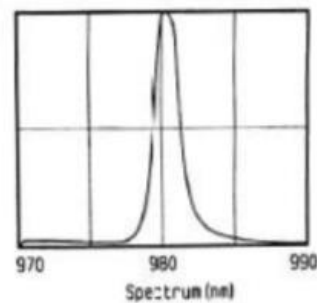

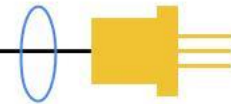

MECHANICAL OUTLINE (unit: mm)

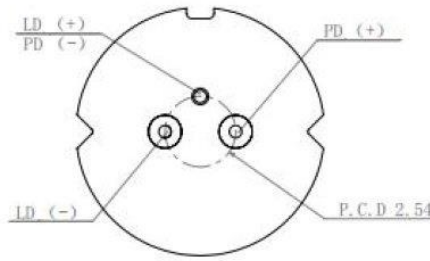
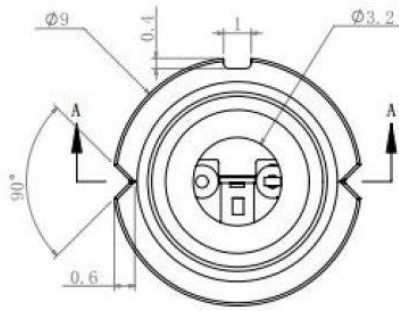

A-A

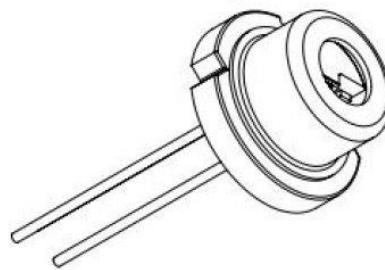
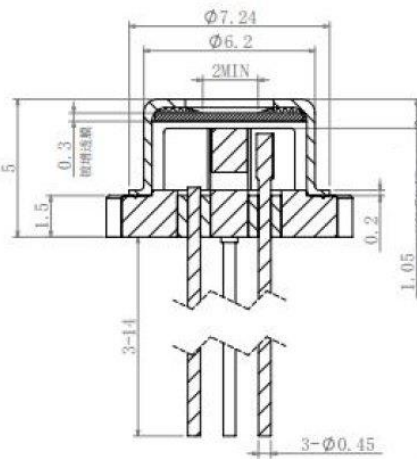

TO-9 Package

Unit: mm

ADDITIONAL NOTES

- Do not operate the device above maximum ratings. Doing so may cause unexpected and permanent damage to the device.
- Take precautions to avoid electrostatic discharge and/or momentary power spikes. A change in the characteristics of the laser or premature failure may result.
- Proper heat sinking of the device assures stability and lifetime. Always ensure that maximum operating temperatures are not exceeded.
- Observing visible or invisible laser beams with human eye directly, or indirectly, can cause permanent damage. Use a camera to observe the laser.
- No laser device should be used in any application or situation where life or property is at risk in the event of device failure.
- Specifications are subject to change without notice. Ensure that you have the latest specification by contacting us prior to purchase or use of the product.