

850nm 5mW 50°C Laser Diode in TO-18 ϕ 5.6mm Package

Part No. LD850A5C15

FEATURES

- 850nm 5mW laser diode
- Package: TO-18 (5.6mm)
- Low operation current
- Cost effective

APPLICATIONS

- Bar code scanner
- Laser printer
- Military

ABSOLUTE MAXIMUM RATINGS

Parameter	Symbol	Rating	Unit
Optical output power	P_O	5	mW
Reverse voltage (LD)	V_{RL}	3.5	V
Reverse voltage (PD)	V_{RD}	30	V
Forward current (PD)	I_{FD}	10	mA
Operating temperature	T_{opr}	-10 to +50	°C
Storage temperature	T_{stg}	-40 to +85	°C

ELECTRICAL AND OPTICAL CHARACTERISTICS ($T_c = 25^\circ\text{C}$)

Parameter	Symbol	Min.	Typ.	Max.	Unit	Conditions
Peak wavelength	λ	840	845	850	nm	$P_O = 5\text{mW}$
Threshold current	I_{th}	-	19	25	mA	
Operating current	I_{op}	-	26	35	mA	$P_O = 5\text{mW}$
Operating voltage	V_{op}	-	1.8	2.0	V	$P_O = 5\text{mW}$
Slope efficiency	η	0.5	0.9	1.1	mW/mA	$P_O = 3\text{-}5\text{mW}$
Monitor current	I_m	0.2	0.5	0.8	mA	$P_O = 5\text{mW}$, $V_{RD} = 5\text{V}$
Parallel divergence angle	$\Theta_{//}$	6	9	14	deg	$P_O = 5\text{mW}$
Perpendicular divergence angle	Θ_{\perp}	27	32	36	deg	$P_O = 5\text{mW}$
Parallel FFP deviation angle	$\Delta\Theta_{//}$	-3	0	3	deg	$P_O = 5\text{mW}$
Perpendicular FFP deviation angle	$\Delta\Theta_{\perp}$	-3	0	3	deg	$P_O = 5\text{mW}$
Emission point accuracy	$\Delta x \Delta y$	-80	0	80	um	$P_O = 5\text{mW}$
Emission point accuracy	Δz	-40	0	40	um	$P_O = 5\text{mW}$

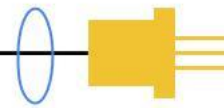

TYPICAL CHARACTERISTICS

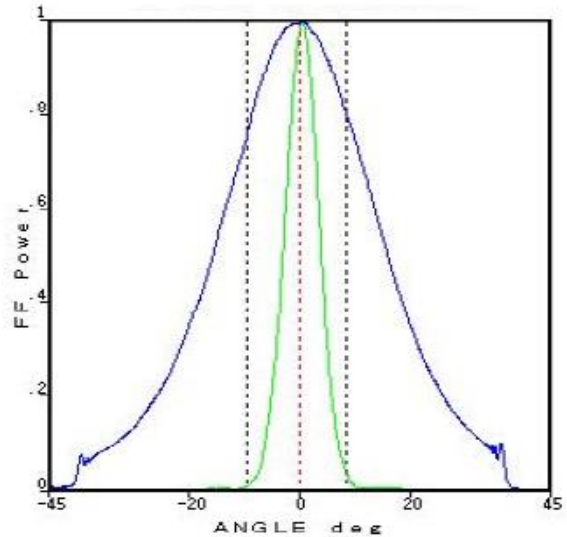
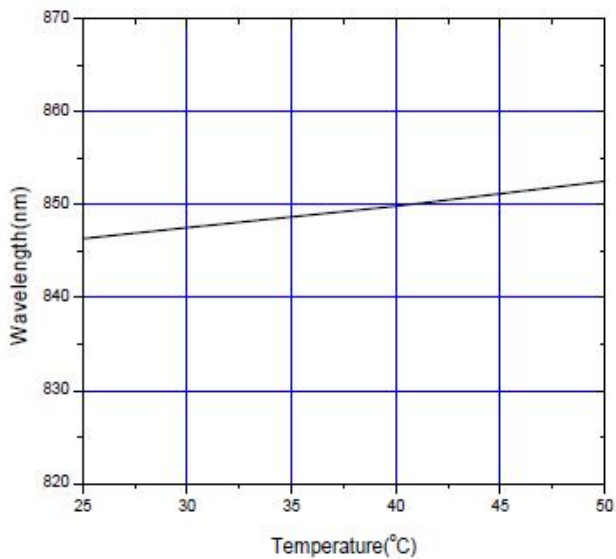
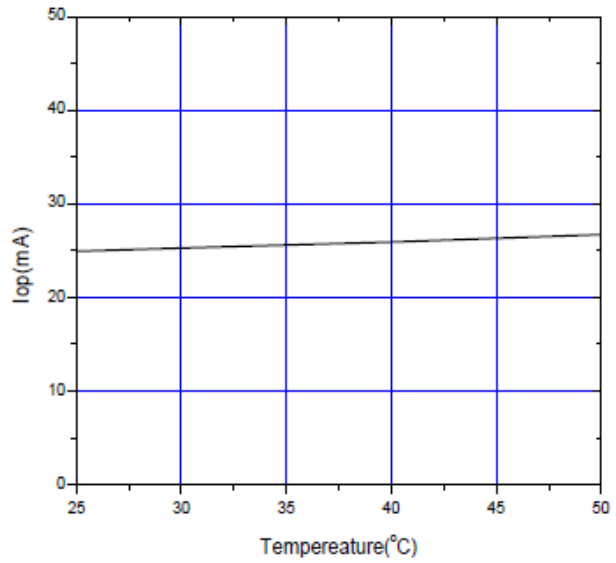
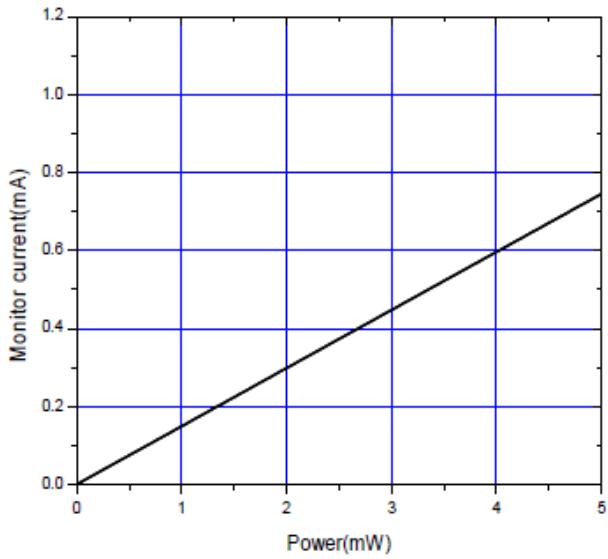
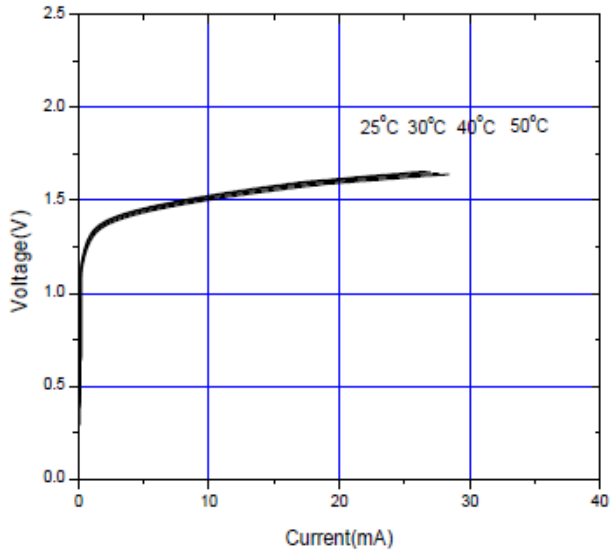
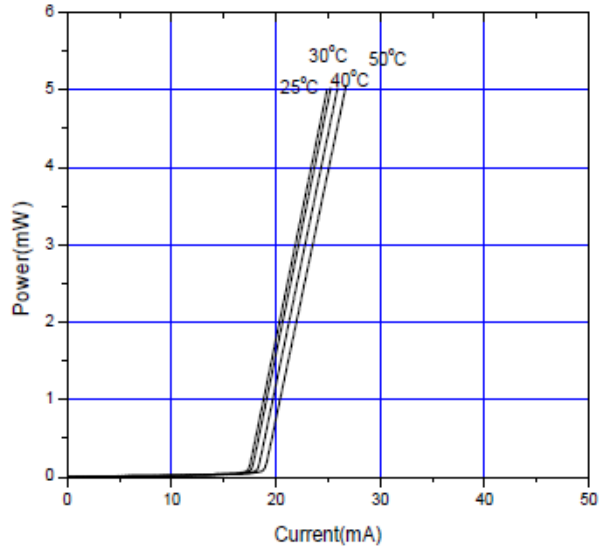

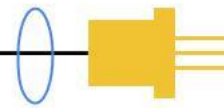

MECHANICAL OUTLINE (unit: mm)

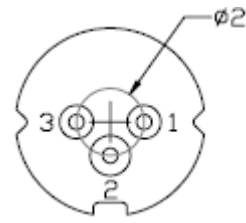
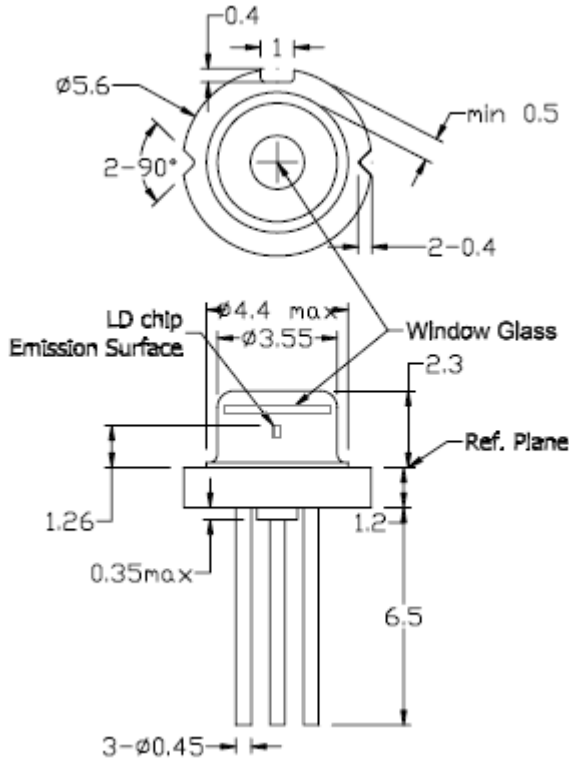

Pin Configuration

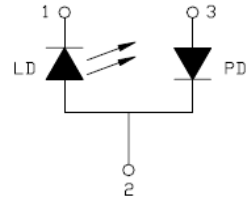

ADDITIONAL NOTES

- Do not operate the device above maximum ratings. Doing so may cause unexpected and permanent damage to the device.
- Take precautions to avoid electrostatic discharge and/or momentary power spikes. A change in the characteristics of the laser or premature failure may result.
- Proper heat sinking of the device assures stability and lifetime. Always ensure that maximum operating temperatures are not exceeded.
- Observing visible or invisible laser beams with human eye directly, or indirectly, can cause permanent damage. Use a camera to observe the laser.
- No laser device should be used in any application or situation where life or property is at risk in the event of device failure.
- Specifications are subject to change without notice. Ensure that you have the latest specification by contacting us prior to purchase or use of the product.