

650nm 5mW 70°C Laser Diode in TO-18 ϕ 5.6mm Package

Part No. LD650C5C27

FEATURES

- 650nm 5mW AlGaInP Visible Laser Diode
- Excellent far field pattern
- Higher power
- High accuracy
- Package: TO-18 (dia. 5.6mm)

APPLICATIONS

- Laser pointer
- Laser leveler
- Bar code scanner

ABSOLUTE MAXIMUM RATINGS

Parameter	Symbol	Condition	Rating	Unit
Light output power	P_O	CW	7	mW
Reverse voltage (LD)	V_{RL}	-	2	V
Reverse voltage (PD)	V_{RD}	-	30	V
Forward current (PD)	I_{FD}	-	10	mA
Case temperature	T_C	-	-20 to +70	°C
Storage temperature	T_S	-	-40 to +85	°C

ELECTRICAL AND OPTICAL CHARACTERISTICS ($T_C = 25^\circ\text{C}$)

Parameter	Symbol	Min.	Typ.	Max.	Unit	Conditions
Peak wavelength	λ	645	655	660	nm	$P_O = 5\text{mW}$
Threshold current	I_{th}	-	18	30	mA	
Operating current	I_{op}	-	30	42	mA	$P_O = 5\text{mW}$
Operating voltage	V_{op}	-	2.2	2.5	V	$P_O = 5\text{mW}$
Differential efficiency	η	0.2	0.45	0.6	mW/mA	$P_O = 3\text{-}5\text{mW}$
Monitor current	I_m	0.1	0.22	0.4	mA	$P_O = 5\text{mW}, V_{RD} = 5\text{V}$
Parallel divergence angle	$\Theta_{//}$	7	8	9.5	deg	$P_O = 5\text{mW}$
Perpendicular divergence angle	Θ_{\perp}	24	28	34	deg	
Parallel FFP deviation angle	$\Delta \Theta_{//}$	-3	0	+3	deg	
Perpendicular FFP deviation angle	$\Delta \Theta_{\perp}$	-3	0	+3	deg	
Emission point accuracy	$\Delta x \Delta y \Delta z$	-80	0	+80	um	

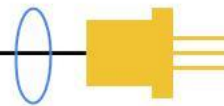

TYPICAL CHARACTERISTICS

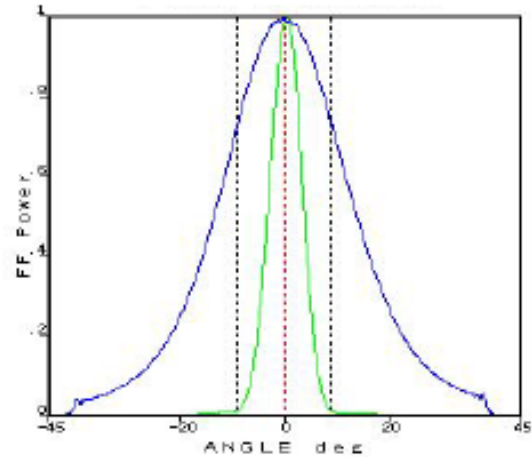
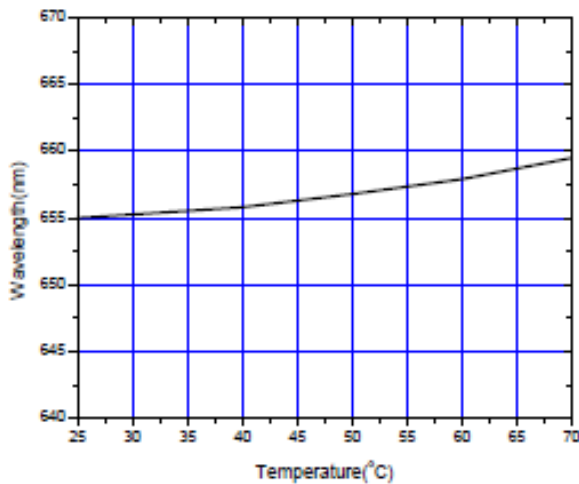
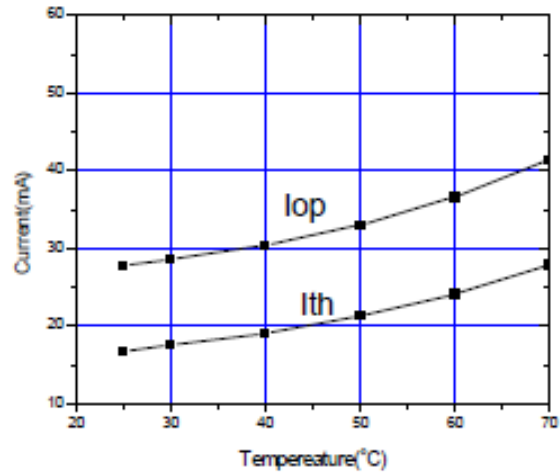
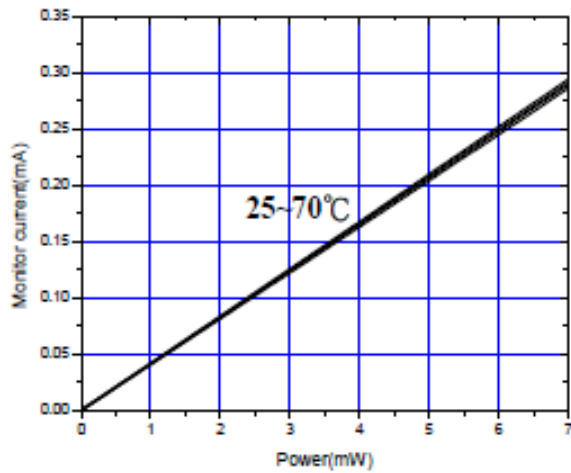
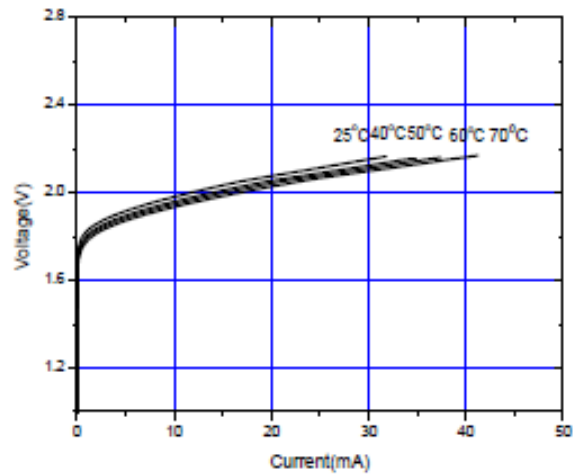
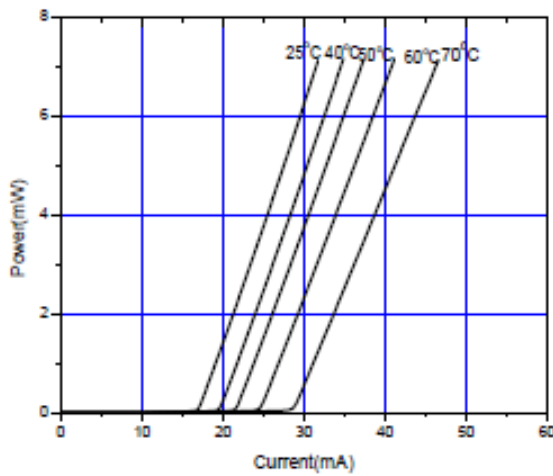

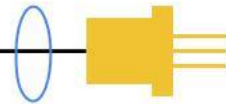

MECHANICAL OUTLINE (unit: mm)

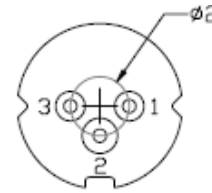
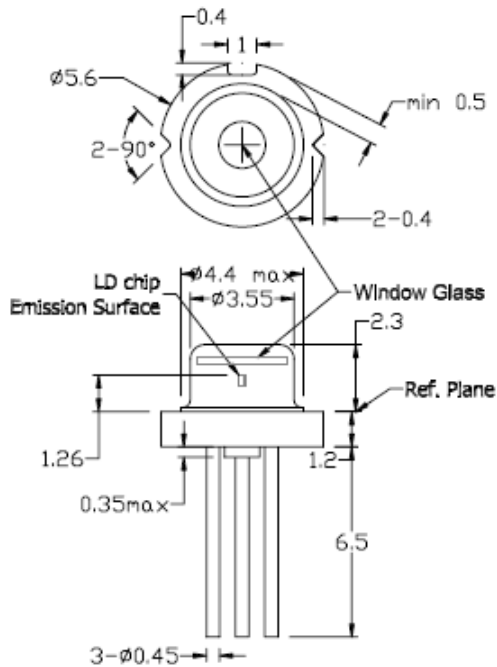

Pin Configuration

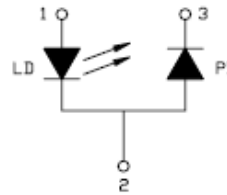

ADDITIONAL NOTES

- Do not operate the device above maximum ratings. Doing so may cause unexpected and permanent damage to the device.
- Take precautions to avoid electrostatic discharge and/or momentary power spikes. A change in the characteristics of the laser or premature failure may result.
- Proper heat sinking of the device assures stability and lifetime. Always ensure that maximum operating temperatures are not exceeded.
- Observing visible or invisible laser beams with human eye directly, or indirectly, can cause permanent damage. Use a camera to observe the laser.
- No laser device should be used in any application or situation where life or property is at risk in the event of device failure.
- Specifications are subject to change without notice. Ensure that you have the latest specification by contacting us prior to purchase or use of the product.