**650nm 7mW 85°C Laser Diode in TO-18 ϕ 5.6mm Package**

Part No. LD650A7C18

FEATURES

- 650nm 7mW AlGaInP Visible Laser Diode
- High operating temperature
- High power
- High reliability
- Package: TO-18 (dia. 5.6mm)

APPLICATIONS

- Automobile DVD
- Bar code readers
- High reliability laser instrument
- PM2.5 detection (for outdoor)

ABSOLUTE MAXIMUM RATINGS

Parameter	Symbol	Condition	Rating	Unit
Light output power	P_O	CW	10	mW
Reverse voltage (LD)	V_{RL}	-	2	V
Reverse voltage (PD)	V_{RD}	-	30	V
Forward current (PD)	I_{FD}	-	10	mA
Case temperature	T_C	-	-10 to +85	°C
Storage temperature	T_S	-	-40 to +85	°C

ELECTRICAL AND OPTICAL CHARACTERISTICS ($T_C = 25^\circ\text{C}$)

Parameter	Symbol	Min.	Typ.	Max.	Unit	Conditions
Peak wavelength	λ	645	655	660	nm	$P_O = 7\text{mW}$
Threshold current	I_{th}	-	20	28	mA	
Operating current	I_{op}	-	28	35	mA	$P_O = 7\text{mW}$
Operating voltage	V_{op}	-	2.2	2.5	V	$P_O = 7\text{mW}$
Differential efficiency	η	0.7	0.85	1.10	mW/mA	$P_O = 3\text{-}5\text{mW}$
Monitor current	I_m	0.1	0.2	0.3	mA	$P_O = 7\text{mW}, V_{RD} = 5\text{V}$
Parallel divergence angle	$\theta_{//}$	6	9	12	deg	$P_O = 7\text{mW}$
Perpendicular divergence angle	θ_{\perp}	25	28	32	deg	
Parallel FFP deviation angle	$\Delta\theta_{//}$	-2	0	+2	deg	
Perpendicular FFP deviation angle	$\Delta\theta_{\perp}$	-2	0	+2	deg	
Emission point accuracy	$\Delta x \Delta y \Delta z$	-80	0	+80	um	

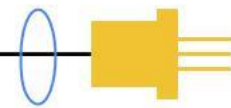

TYPICAL CHARACTERISTICS

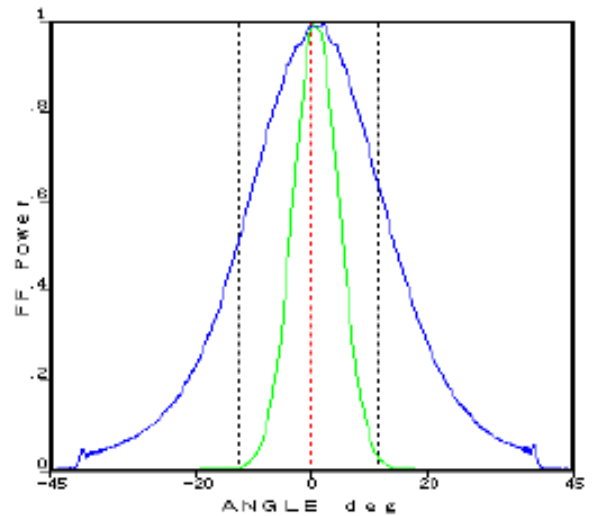
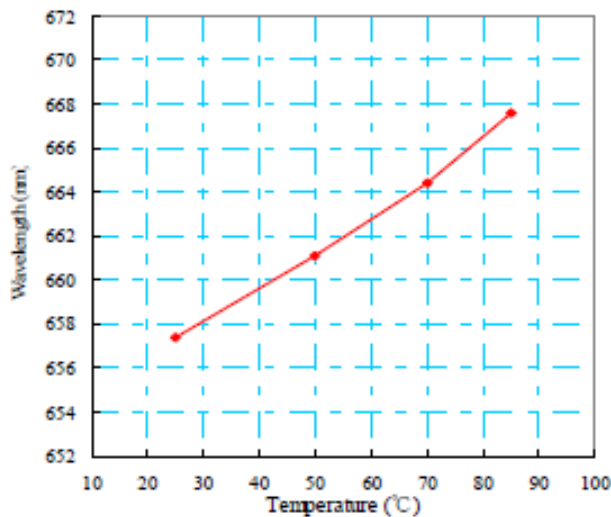
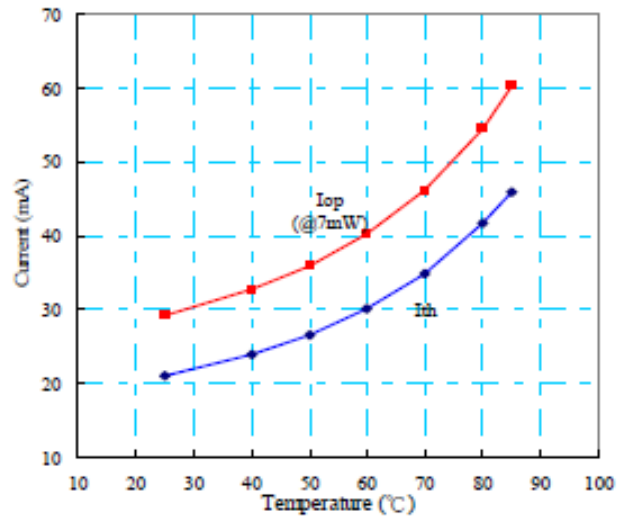
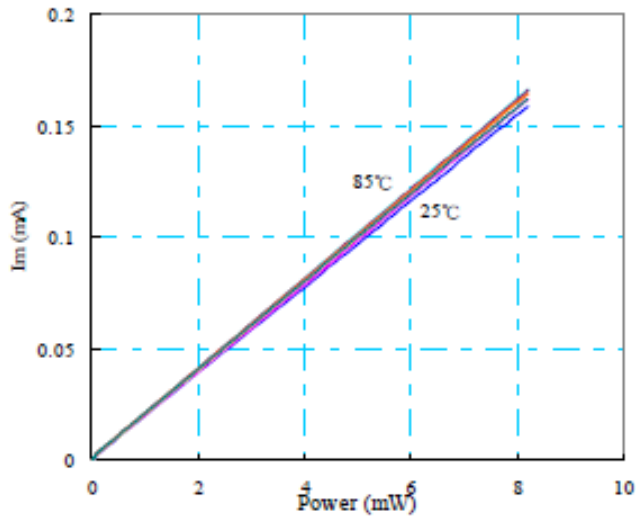
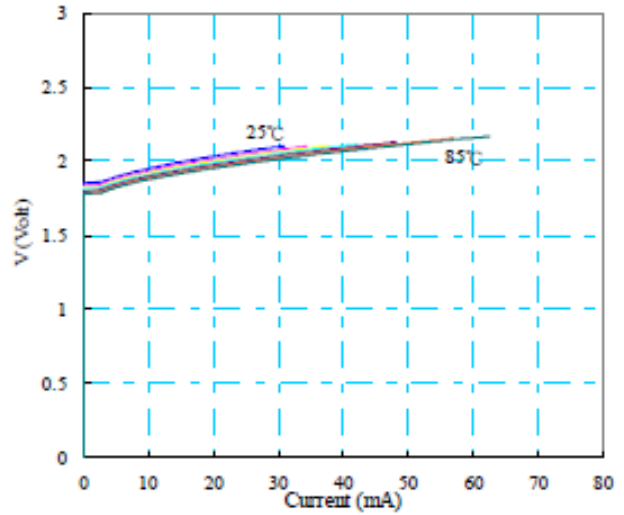
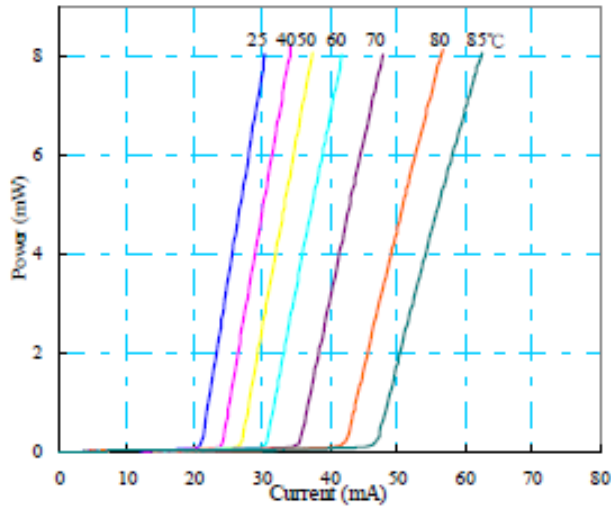

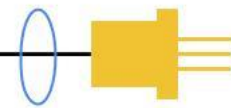

MECHANICAL OUTLINE (unit: mm)

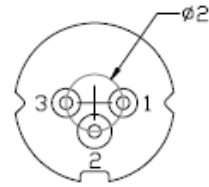
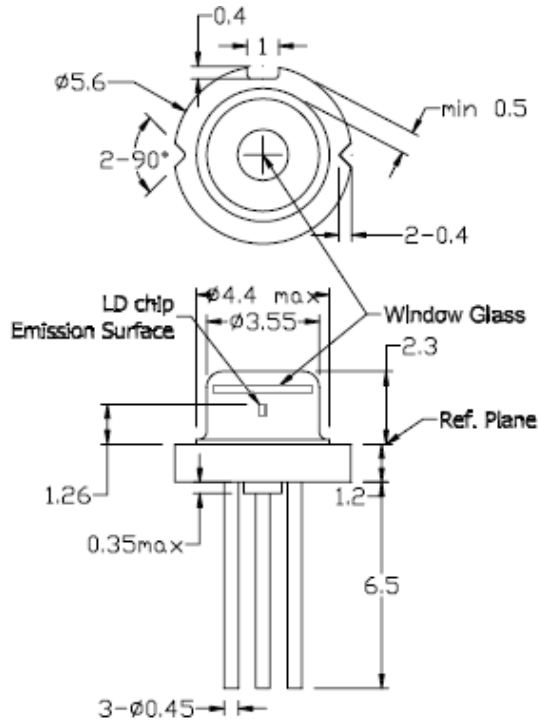

Pin Configuration

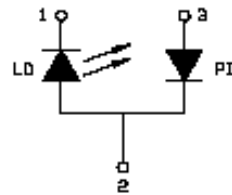

ADDITIONAL NOTES

- Do not operate the device above maximum ratings. Doing so may cause unexpected and permanent damage to the device.
- Take precautions to avoid electrostatic discharge and/or momentary power spikes. A change in the characteristics of the laser or premature failure may result.
- Proper heat sinking of the device assures stability and lifetime. Always ensure that maximum operating temperatures are not exceeded.
- Observing visible or invisible laser beams with human eye directly, or indirectly, can cause permanent damage. Use a camera to observe the laser.
- No laser device should be used in any application or situation where life or property is at risk in the event of device failure.
- Specifications are subject to change without notice. Ensure that you have the latest specification by contacting us prior to purchase or use of the product.