

## 635nm 5mW 50°C Laser Diode in TO-33 $\phi$ 3.3mm Package

Part No. LD635A5A15

### FEATURES

- 635nm 5mW AlGaInP Visible Laser Diode
- Small size
- High monitor current
- High temperature operation
- Package: TO-33 (dia. 3.3mm)

### APPLICATIONS

- High precision measuring instruments
- High precision industrial laser markers
- Survey and engineering instruments

### ABSOLUTE MAXIMUM RATINGS

Parameter	Symbol	Condition	Rating	Unit
Light output power	$P_O$	CW	7	mW
Reverse voltage (LD)	$V_{RL}$	-	2	V
Reverse voltage (PD)	$V_{RD}$	-	30	V
Forward current (PD)	$I_{FD}$	-	10	mA
Case temperature	$T_C$	-	-10 to +50	°C
Storage temperature	$T_S$	-	-40 to +85	°C

### ELECTRICAL AND OPTICAL CHARACTERISTICS ( $T_C = 25^\circ\text{C}$ )

Parameter	Symbol	Min.	Typ.	Max.	Unit	Conditions
Peak wavelength	$\lambda$	630	635	640	nm	$P_O = 5\text{mW}$
Threshold current	$I_{th}$	-	24	30	mA	
Operating current	$I_{op}$	-	33	40	mA	$P_O = 5\text{mW}$
Operating voltage	$V_{op}$	-	2.2	2.5	V	$P_O = 5\text{mW}$
Differential efficiency	$\eta$	0.4	0.6	0.8	mW/mA	$P_O = 3\text{-}5\text{mW}$
Monitor current	$I_m$	0.1	0.15	0.3	mA	$P_O = 5\text{mW}$ , $V_{RD} = 5\text{V}$
Parallel divergence angle	$\Theta_{//}$	6	7.5	11	deg	$P_O = 5\text{mW}$
Perpendicular divergence angle	$\Theta_{\perp}$	30	33	40	deg	
Parallel FFP deviation angle	$\Delta \Theta_{//}$	-2	0	+2	deg	
Perpendicular FFP deviation angle	$\Delta \Theta_{\perp}$	-2	0	+2	deg	
Emission point accuracy	$\Delta x \Delta y \Delta z$	-60	0	+60	um	

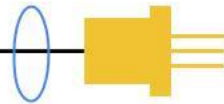

### TYPICAL CHARACTERISTICS

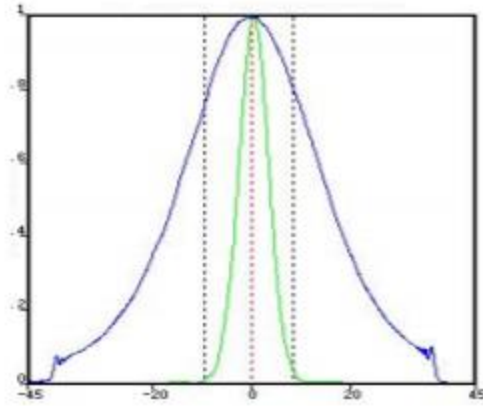
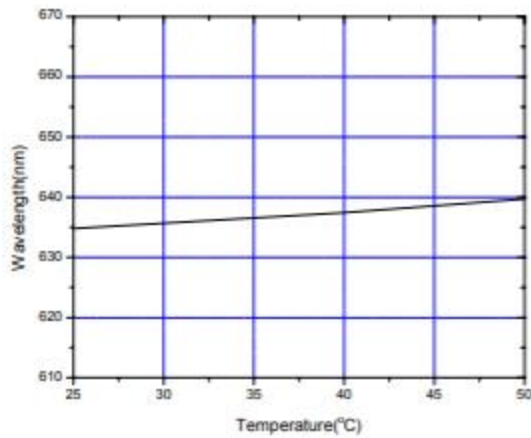
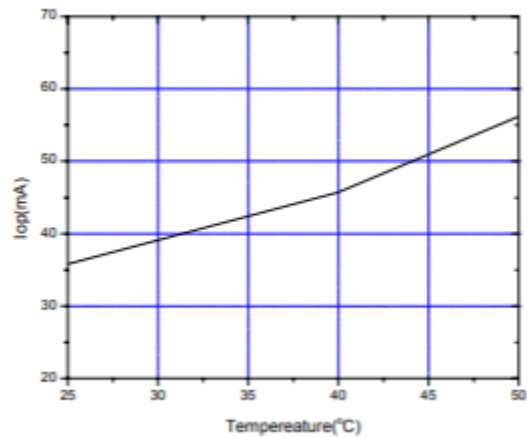
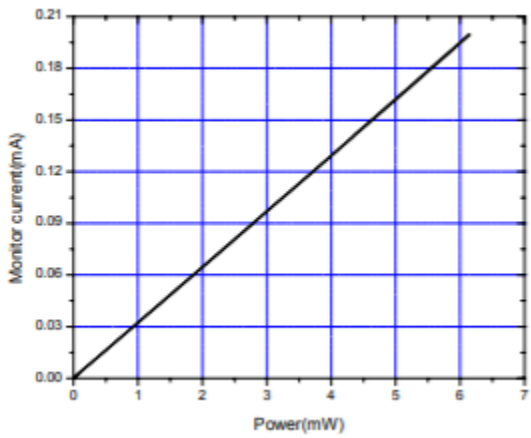
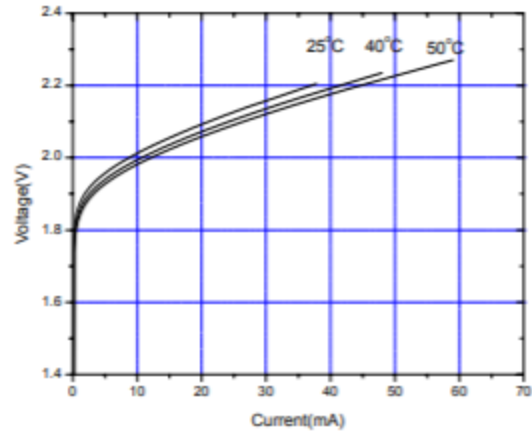
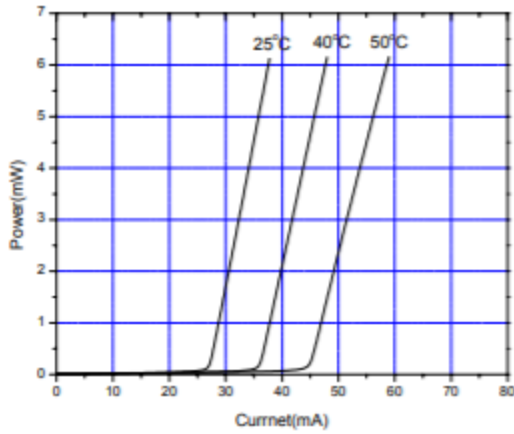

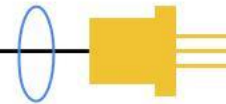

## MECHANICAL OUTLINE (unit: mm)

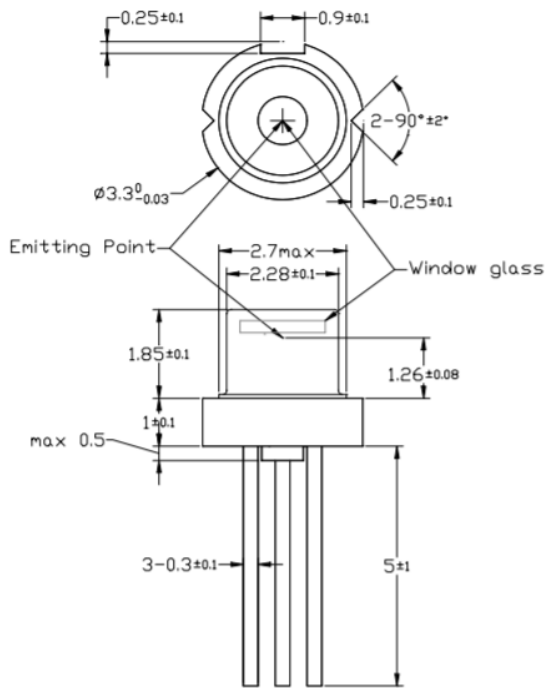

## Pin Configuration

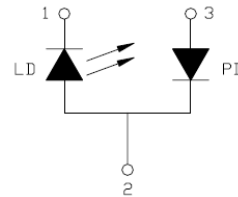

## ADDITIONAL NOTES

- Do not operate the device above maximum ratings. Doing so may cause unexpected and permanent damage to the device.
- Take precautions to avoid electrostatic discharge and/or momentary power spikes. A change in the characteristics of the laser or premature failure may result.
- Proper heat sinking of the device assures stability and lifetime. Always ensure that maximum operating temperatures are not exceeded.
- Observing visible or invisible laser beams with human eye directly, or indirectly, can cause permanent damage. Use a camera to observe the laser.
- No laser device should be used in any application or situation where life or property is at risk in the event of device failure.
- Specifications are subject to change without notice. Ensure that you have the latest specification by contacting us prior to purchase or use of the product.