

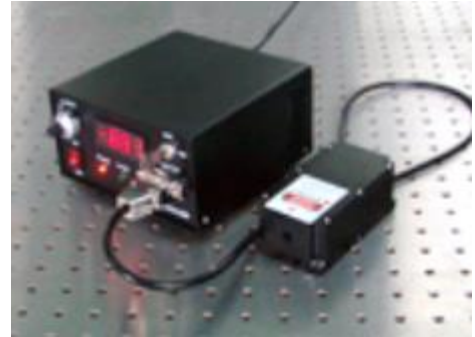

GD1550 Series 1550nm Diode Laser System up to 30mW (TEM₀₀)

Overview

The GD1550 series diode laser is ideal for applications that require a wavelength of 1550nm and output power levels up to 30mW. The laser features TEM₀₀ mode, narrow linewidth, no jump mode output in operating current range, compact design, long operating lifetime, easy operation and FDA-compliant system with driver. The laser is widely used in optical fiber gas detection system, optical sensing, fiber communications, measurement, communication, spectrum analysis, and many other applications.



Specifications

Model Number	GD1550-XYPQ	
Wavelength (nm)	1550±2	
Output power (mW)	>5 (X=5), >20 (X=20), >30 (X=30)	
Transverse mode	TEM ₀₀	
Operating mode	CW	
Power stability (rms, over 4 hours)	<5% (P=A), <3% (P=E), <2% (P=2)	
Ellipticity	>0.95	
M ² factor	<1.1	
Spectral linewidth (MHz)	~3	
Beam diameter at aperture (1/e ² , mm)	~1.0	
Beam divergence, full angle (mrad)	<1.5	
SMSR (dB)	35	
Warm-up time (minutes)	<5	
Beam height from base plate (mm)	25	
Operating temperature (°C)	25+/-3	
Dimensions of laser head (mm)	146(L)×58(W) ×45(H) mm ³	
Weight of laser head (kg)	0.7 kg	
Power supply		
Elite Power Supply (Y=E)	Input voltage	85-264VAC
	Dimensions	171(L) ×130(W) ×62.2(H) mm ³
	Weight	1.2 kg
	Notes	Fixed output power
Laboratory Power Supply (Y=L)	Input voltage	85-264VAC
	Dimensions	188.6(L) ×155(W) ×92(H) mm ³
	Weight	1.5 kg
	Notes	Adjustable output power
Modulation option	None (Q=0)	
	TTL	1Hz-1kHz (Q=T1), 1kHz-10kHz (Q=T2), 10kHz-30kHz (Q=T3)
	Analog	1Hz-1kHz (Q=A1), 1kHz-10kHz (Q=A2), 10kHz-30kHz (Q=A3)
Expected lifetime (hours)	10,000	
Warranty period	10 months	
FDA Compliance	FDA CDRH Title 21 CFR 1040.10/11 Class IIIb	

Remarks:

- The laser head needs to be used on a heat sink with good heat dissipation.
- Specifications of the CW laser is based on the laser performance at full power output after the specified warmup period. The stability of output power may change when output power is adjusted at a different power level.



Outline Dimensions (unit: mm)

Laser Head

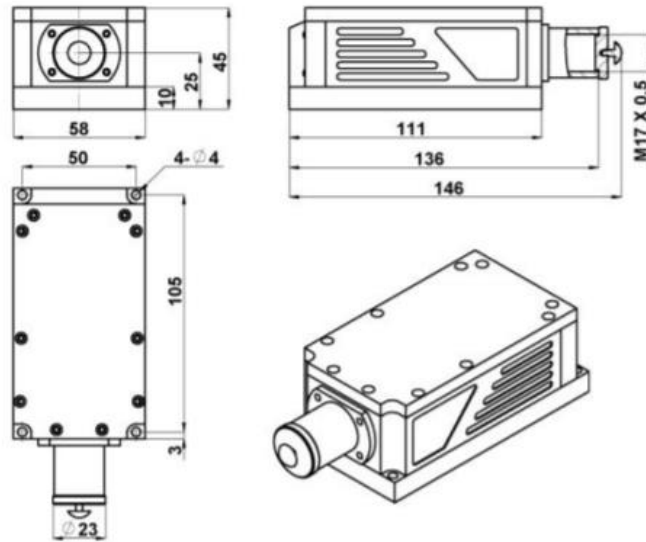

Power Supply Options

Elite Power Supply (Y=E)

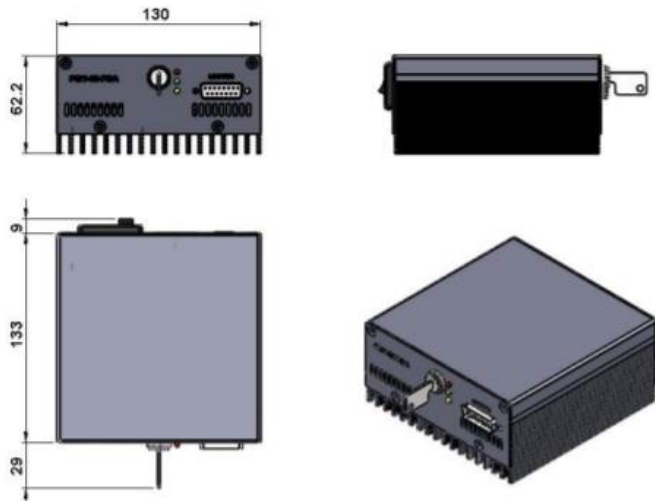

Laboratory Power Supply (Y=L)

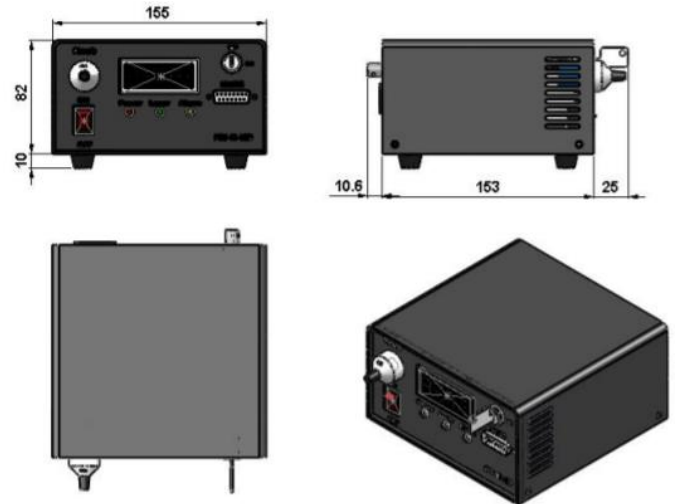

Note: The above specifications are subject to change without notice.