



FCM655 Series 655nm 100mW Fiber Coupled Laser Modules

With 400um Fiber Core Diameter, Wide Operating Temperature, no TEC, and High Reliability

Overview

The FCM655 series fiber coupled laser modules are ideal for applications that require a wavelength of 655nm and output power of 100mW. The MM fiber coupled laser module features wide temperature operation (no TEC), high reliability and low cost. The laser is commonly used in orientation, alignment, measurement, and many other applications.



Specifications

Model Number	FCM655-P100Y
Wavelength (nm)	655
Output power (mW)	~100
Fiber	400um core diameter
Type of connector	FC (Y=FC) or SMA905 (Y=SMA)
Operating mode	CW
Power stability (rms)	<5%, over 4 hours at constant temperature after warmup
Operating temperature (°C)	15-30
Dimensions of laser	Ø30mm x 153mm
PCB Driver	5VDC
Expected lifetime (hours)	10000
Warranty period	4 months

Outline Dimensions (unit: mm)

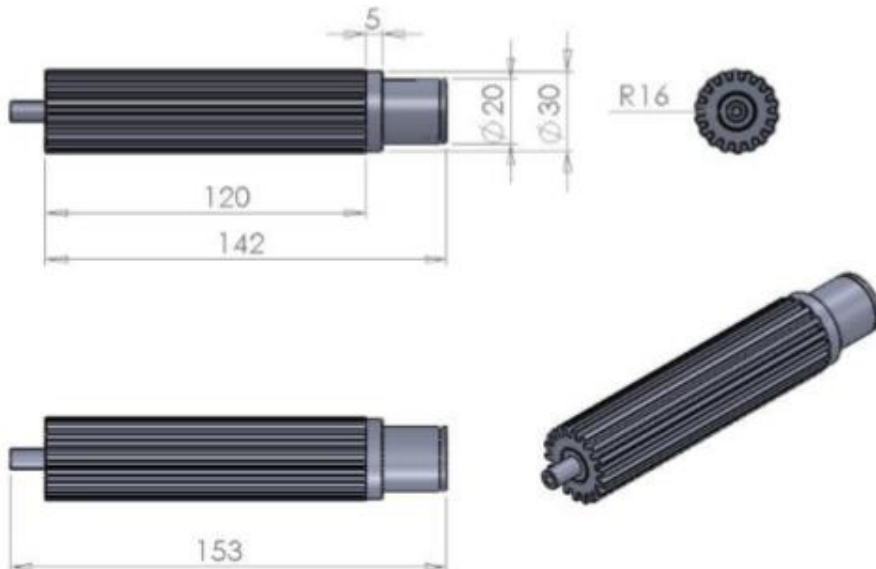

Additional Notes

- The FCM655 series laser modules are designated solely as OEM components for incorporation into the customer's end products. Therefore, it is the customer's responsibility to comply with the appropriate requirements of FDA 21CFR, section 1040.10 and 1040.11 for complete laser products. For the code of FDA regulations, please refer to [FDA Performance Standards for Light-Emitting Products](#) for detailed information.
- Specifications are subject to change without notice.

Lasermate Group, Inc.

19608 Camino De Rosa, Walnut, CA 91789, USA

Tel: (909)718-0999 | Fax: (909)718-0998 | E-mail: info@lasermate.com | URL: <http://www.lasermate.com>