



FCM532V Series 532nm 50mW Fiber Coupled Laser Modules

With 400um Fiber Core Diameter, Wide Operating Temperature and High Reliability

Overview

The FCM532V series fiber coupled laser modules are ideal for applications that require a wavelength of 532nm and output power up to 50mW. The laser module features wide temperature operation and high reliability. The laser is commonly used in orientation, alignment, measurement, and many other applications.



Specifications

Model Number	FCM532V-P50Y	
Wavelength (nm)	532	
Output power (mW)	~50	
Transverse mode	TEM ₀₀	
Fiber	400um core diameter	
Type of connector	FC (Y=FC) or SMA905 (Y=SMA)	
Operating mode	CW	
Power stability (rms)	<5%, over 4 hours at constant temperature after warmup	
Operating temperature (°C)	15-30	
Dimensions of laser	119(L) x 30(W) x 30(H) mm ³	
Driver	Input voltage	90-264VAC
	Dimensions	105(L) x 47(W) x 38(H) mm ³
	Weight	0.2kg
Expected lifetime (hours)	10000	
Warranty period	4 months	

Outline Dimensions (unit: mm)

Laser Module

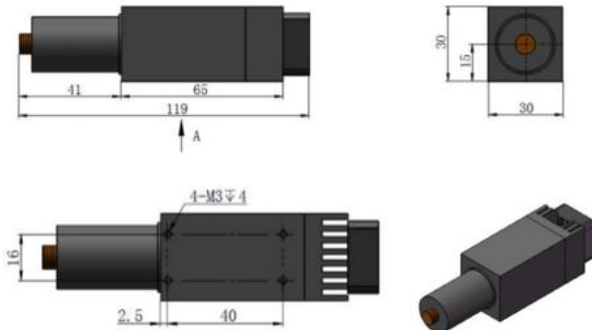

Driver

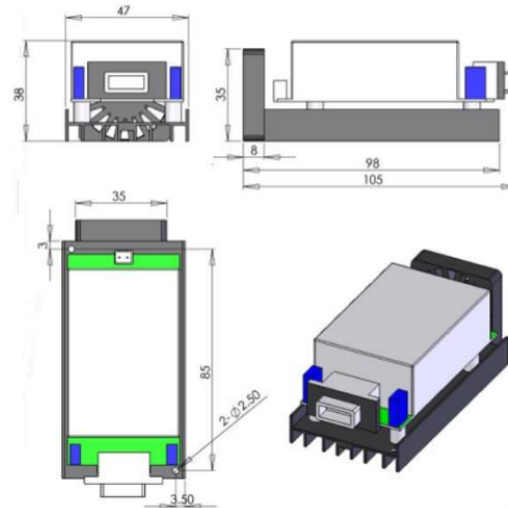

Additional Notes

- The FCM532V series laser modules are designated solely as OEM components for incorporation into the customer's end products. Therefore, it is the customer's responsibility to comply with the appropriate requirements of FDA 21CFR, section 1040.10 and 1040.11 for complete laser products. For the code of FDA regulations, please refer to [FDA Performance Standards for Light-Emitting Products](#) for detailed information.
- Specifications are subject to change without notice.

Lasermate Group, Inc.

19608 Camino De Rosa, Walnut, CA 91789, USA

Tel: (909)718-0999 | Fax: (909)718-0998 | E-mail: info@lasermate.com | URL: <http://www.lasermate.com>