

FCM447V Series 447nm 50mW Fiber Coupled Laser Modules

With 400um Fiber Core Diameter, Wide Operating Temperature and High Reliability

Overview

The FCM447V series fiber coupled laser modules are ideal for applications that require a wavelength of 447nm and output power up to 50mW. The laser module features wide temperature operation and high reliability. The laser is commonly used in orientation, alignment, measurement, and many other applications.



Specifications

| | | |
|----------------------------|--|--|
| Model Number | FCM447V-P50Y | |
| Wavelength (nm) | 447 | |
| Output power (mW) | ~50 | |
| Transverse mode | TEM ₀₀ | |
| Fiber | 400um core diameter | |
| Type of connector | FC (Y=FC) or SMA905 (Y=SMA) | |
| Operating mode | CW | |
| Power stability (rms) | <5%, over 4 hours at constant temperature after warmup | |
| Operating temperature (°C) | 15-30 | |
| Dimensions of laser | 119(L) x 30(W) x 30(H) mm ³ | |
| Driver | Input voltage | 90-264VAC |
| | Dimensions | 105(L) x 47(W) x 38(H) mm ³ |
| | Weight | 0.2kg |
| Expected lifetime (hours) | 10000 | |
| Warranty period | 4 months | |

Outline Dimensions (unit: mm)

Laser Module

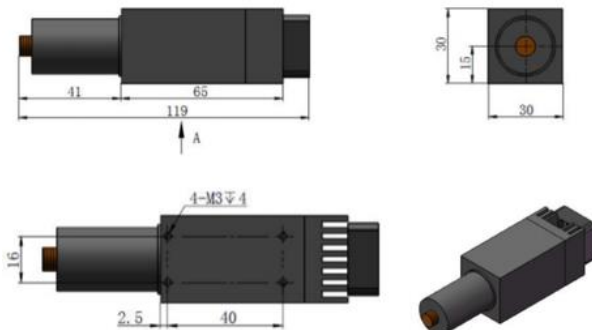

Driver

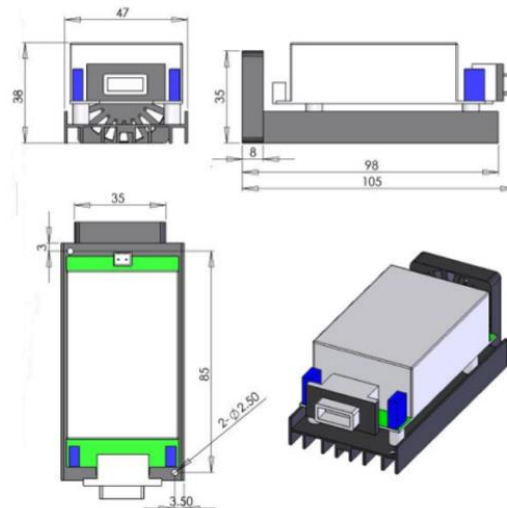

Additional Notes

- The FCM447V series laser modules are designated solely as OEM components for incorporation into the customer's end products. Therefore, it is the customer's responsibility to comply with the appropriate requirements of FDA 21CFR, section 1040.10 and 1040.11 for complete laser products. For the code of FDA regulations, please refer to [FDA Performance Standards for Light-Emitting Products](#) for detailed information.
- Specifications are subject to change without notice.

Lasermate Group, Inc.

19608 Camino De Rosa, Walnut, CA 91789, USA

Tel: (909)718-0999 | Fax: (909)718-0998 | E-mail: info@lasermate.com | URL: <http://www.lasermate.com>