



DLNE655 Series 655nm Narrow Linewidth Diode Laser System up to 30mW

Overview

The DLNE655 series diode laser is ideal for applications that require a wavelength of 655nm and output power levels up to 30mW. The laser features narrow spectral linewidth, stable wavelength, ultra-compact design, long operating lifetime, easy operation and FDA-compliant system with driver. The laser is widely used in precision measurement, high resolution spectrum analysis, and many other applications.



Specifications

Model Number	DLNE655-XYPZ		
Wavelength (nm)	655±10		
Output power (mW)	>10 (X=10), >30 (X=30)		
Transverse mode	Near TEM ₀₀		
Operating mode	CW		
Power stability (rms, over 4 hours)	<1% (P=D)		
Spectral linewidth (nm)	<0.06 (Z=M), <0.03 (Z=N)		
M ² factor	<1.5		
Beam diameter at aperture (1/e ² , mm)	~3.0		
Beam divergence, full angle (mrad)	<1.0		
Polarization ratio	>50:1, Horizontal ±5 degree		
Warm-up time (minutes)	<5		
Beam height from base plate (mm)	30		
Operating temperature (°C)	20-30		
Dimensions of laser head (mm)	122.5(L)×65(W) ×50(H) mm ³		
Weight of laser head (kg)	1.0 kg		
Power supply			
Elite Power Supply (Y=E)	Input voltage	85-264VAC	
	Dimensions	171(L) ×130(W) ×62.2(H) mm ³	
	Weight	1.2 kg	
	Notes	Fixed output power	
Expected lifetime (hours)	10,000		
Warranty period	10 months		
FDA Compliance	FDA CDRH Title 21 CFR 1040.10/11 Class IIIb		

Remarks:

- Specifications of the CW laser is based on the laser performance at full power output after the specified warmup period. The stability of output power may change when output power is adjusted at a different power level.



Outline Dimensions (unit: mm)

Laser Head

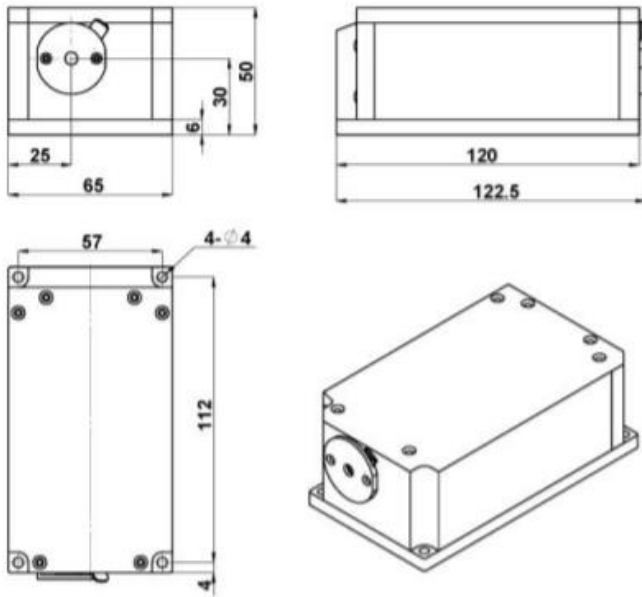

Power Supply

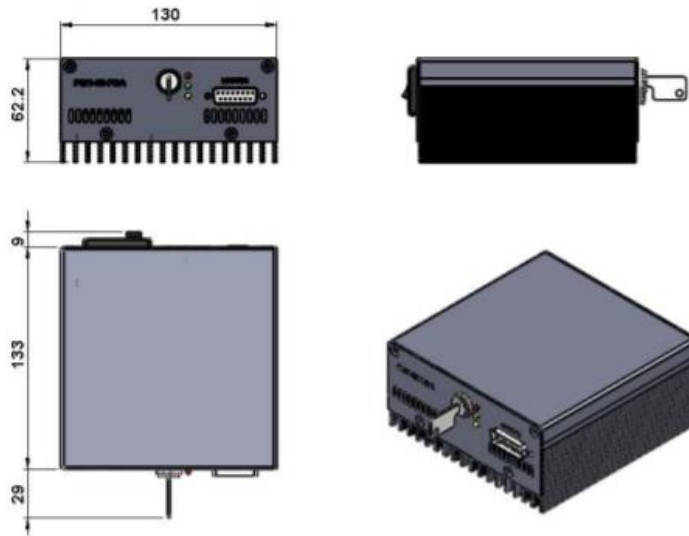

Note: The above specifications are subject to change without notice.