

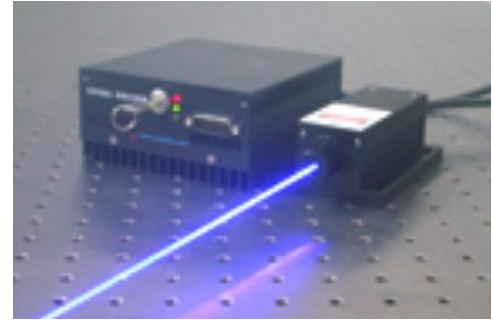

DL450 Series 450nm Diode Laser System up to 1000mW

Overview

The DL450 series diode laser is ideal for applications that require a wavelength of 450nm and output power levels up to 1000mW. The laser features a compact design, long operating lifetime, easy operation, and FDA-compliant system with driver. The laser is widely used in scientific research, laser pointing, laser show, and RGB mixed laser systems applications.



Specifications

Model Number	DL450H-XYPQ		DL450-XYPQ
Wavelength (nm)	450±5		
Output power (mW)	>30 (X=30), >50 (X=50), >80 (X=80)		>500 (X=500), >1000 (X=1W)
Transverse mode	Near TEM ₀₀		Multimode
Operating mode	CW		
Power stability (rms, over 4 hours)	<1% (P=D), <0.5% (P=S)		
M ² factor	<1.5		-
Beam diameter at aperture (1/e ² , mm)	~3.5		<2x5
Beam divergence, full angle (mrad)	<1		<2.5x0.2
Polarization ratio	>50:1 Horizontal ±5 degree		
Warm-up time (minutes)	<5		
Pointing stability after warm-up (mrad)	<0.05		-
Beam height from base plate (mm)	24.8		
Operating temperature (°C)	10-35		
Dimensions of laser head (mm)	143.5(L)x73(W) x46.2(H) mm ³		
Weight of laser head (kg)	0.7 kg		
Power supply options			
Elite Power Supply (Y=E)	Input voltage	85-264VAC	
	Dimensions	171(L) x130(W) x62.2(H) mm ³	
	Weight	1.2 kg	
	Notes	Fixed output power, frequency 1Hz-30kHz	
Laboratory Power Supply (Y=L)	Input voltage	85-264VAC	
	Dimensions	188.6(L) x155(W) x92(H) mm ³	
	Weight	1.5 kg	
	Notes	Adjustable output power, frequency 1Hz-30kHz	
A Version Laboratory Power Supply (Y=T)	Input voltage	100-240VAC	
	Dimensions	162(L) x144(W) x70(H) mm ³	
	Weight	1.0 kg	
	Notes	Adjustable output power, LCD display, frequency 30kHz-100kHz	
Modulation option		None (Q=0)	
	TTL	1Hz-1kHz (Q=T1), 1kHz-10kHz (Q=T2), 10kHz-30kHz (Q=T3), 30kHz-100kHz (Q=T4)	
	Analog	1Hz-1kHz (Q=A1), 1kHz-10kHz (Q=A2), 10kHz-30kHz (Q=A3), 30kHz-100kHz (Q=A4)	
Expected lifetime (hours)	10,000		
Warranty period	10 months		
FDA Compliance	FDA CDRH Title 21 CFR 1040.10/11 Class IIIb		FDA CDRH Title 21 CFR 1040.10/11 Class IV

Remarks:

- Specifications of the CW laser is based on the laser performance at full power output after the specified warmup period. The stability of output power may change when output power is adjusted at a different power level.



Outline Dimensions (unit: mm)

Laser Head

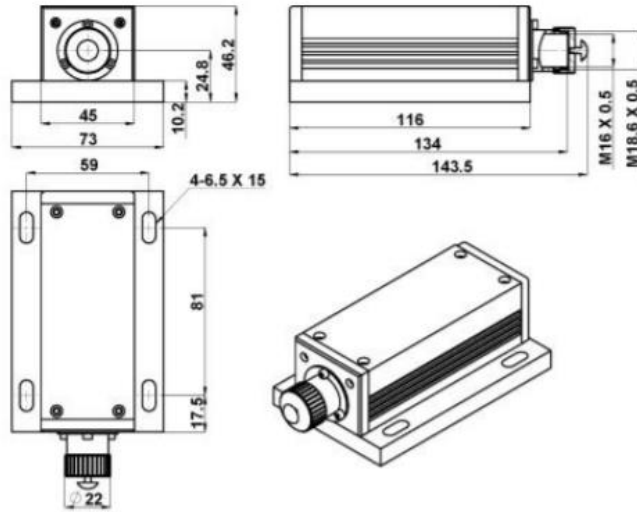

Power Supply Options

Elite Power Supply (Y=E)

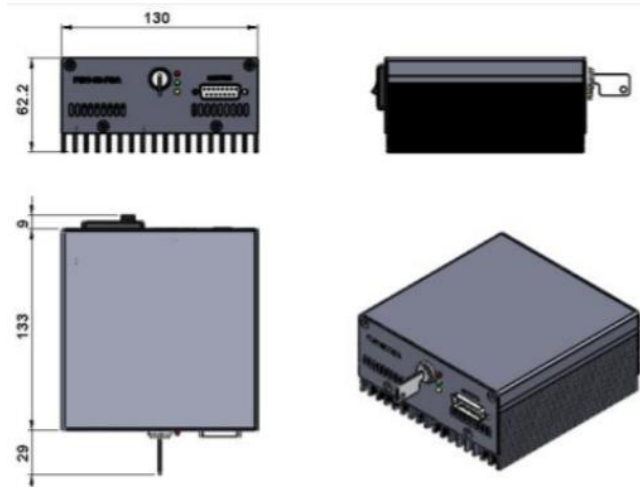

Laboratory Power Supply (Y=L)

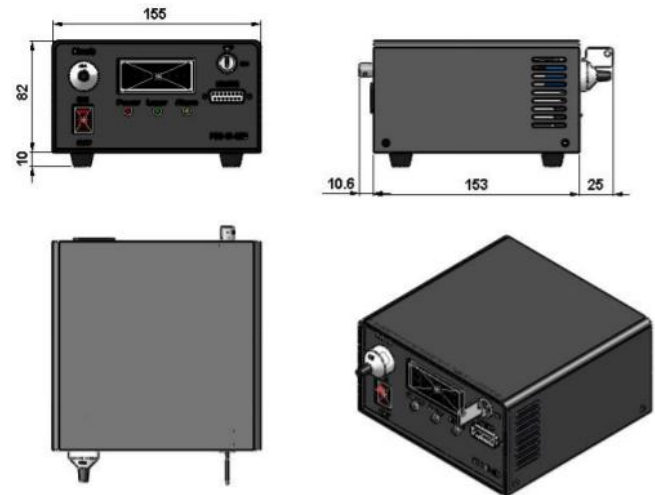

A Version Laboratory Power Supply (Y=T)

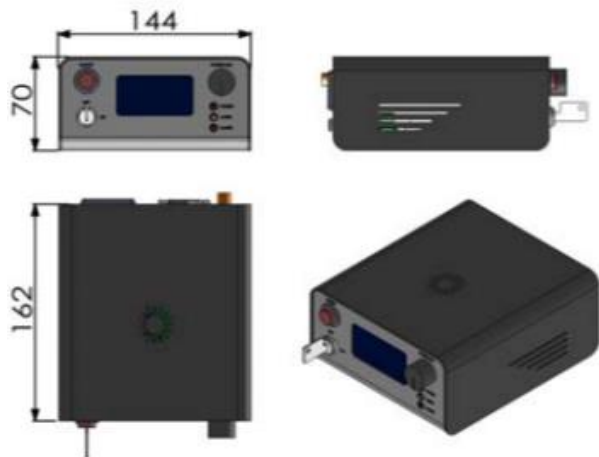

Note: The above specifications are subject to change without notice.