

622Mbps 1550nm Single Mode 80km 1x9 Optical Transceiver with Duplex SC Connector

Model No. CS15D-12A-3U-Px-Cx

No Shield



Backward Clipper



Forward Clipper



FEATURES

- Industry standard 1x9 footprint
- SC duplex connector
- Single power supply 3.3V
- Differential LVPECL data inputs and outputs
- LVPECL signal detect output
- Compatible with solder and aqueous wash processes
- Class 1 laser product complies with EN 60825-1
- Input/Output: DC/DC

ABSOLUTE MAXIMUM RATINGS

PARAMETER	SYMBOL	MIN	MAX	UNIT	NOTES
Storage Temperature	T_S	-40	85	°C	
Supply Voltage	V_{CC}	-0.5	6.0	V	
Input Voltage	V_{IN}	-0.5	V_{CC}	V	
Output Current	I_o	-	50	mA	
Operating Current	I_{OP}	-	500	mA	
Soldering Temperature	T_{SOLD}	-	260	°C	10 seconds on leads

OPERATING ENVIRONMENT

PARAMETER	SYMBOL	MIN	MAX	UNIT	NOTES
Case Operating Temperature	T_C	0	70	°C	CS15D-12A-3U-PC-Cx
		-40	85		CS15D-12A-3U-PI-Cx
Supply Voltage	V_{CC}	3.1	3.5	V	
Supply Current	I_{TX+RX}	-	300	mA	

Lasermate Group, Inc.

19608 Camino De Rosa, Walnut, CA 91789, USA

Tel: (909)718-0999 | Fax: (909)718-0998 | E-mail: info@lasermate.com | URL: <http://www.lasermate.com>

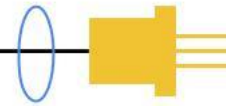
**TRANSMITTER ELECTRO-OPTICAL CHARACTERISTICS ($V_{CC} = 3.1V$ to $3.5V$, $T_C = 0^\circ C$ to $70^\circ C$, $-40^\circ C$ to $85^\circ C$)**

PARAMETER	SYMBOL	MIN	TYP.	MAX	UNIT	NOTES
Data Rate	B	500	622	700	Mbps	
Output Optical Power 9/125um fiber	P_{out}	-3	-	+2	dBm	Average
Extinction Ratio	ER	10	-	-	dB	
Center Wavelength	λ_c	1520	1550	1580	nm	
Spectral Width (-20dB)	$\Delta\lambda$	-	-	1	nm	
Side Mode Suppression Ratio	SMSR	30	-	-	dB	
Rise/Fall Time (20~80%)	$T_{r,f}$	-	-	500	ps	
Total Jitter	TJ	-	-	500	ps	
Output Eye	Compliant with Telcordia GR-253-CORE Issue 3 and ITU-T recommendation G-957					
Transmitter Data Input Voltage-High	$V_{IH}-V_{CC}$	-1.1	-	-0.74	V	
Transmitter Data Input Voltage-Low	$V_{IL}-V_{CC}$	-2.0	-	-1.58	V	
Transmitter Data Input Differential Voltage	V_{DIFF}	0.3	-	1.6	V	

RECEIVER ELECTRO-OPTICAL CHARACTERISTICS ($V_{CC} = 3.1V$ to $3.5V$, $T_C = 0^\circ C$ to $70^\circ C$, $-40^\circ C$ to $85^\circ C$)

PARAMETER	SYMBOL	MIN	TYP.	MAX	UNIT	NOTES
Optical Input Power-Maximum	P_{IN}	-3	-	-	dBm	$BER < 10^{-10}$
Receiver Input Power-Minimum (Sensitivity)	P_{IN}	-	-	-28	dBm	$BER < 10^{-10}$
Operating Center Wavelength	λ_c	1260	-	1610	nm	
Optical Return Loss	ORL	12	-	-	dB	
Signal Detect-Asserted	P_A	-	-	-28	dBm	
Signal Detect-Deasserted	P_D	-40	-	-	dBm	
Signal Detect-Hysteresis	P_A-P_D	1.0	-	-	dB	
Signal Detect Voltage (PECL)-High	$V_{OH}-V_{CC}$	-1.1	-	-0.74	V	
Signal Detect Voltage (PECL)-Low	$V_{OL}-V_{CC}$	-2.0	-	-1.58	V	
Data Output Rise, Fall time (20~80%)	$T_{r,f}$	-	-	0.35	ns	
Data Output Voltage-High	$V_{OH}-V_{CC}$	-1.1	-	-0.74	V	
Data Output Voltage-Low	$V_{OL}-V_{CC}$	-2.0	-	-1.58	V	
Data Output Differential Voltage	V_{DIFF}	0.3	-	1.6	V	

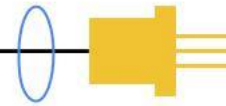

DRAWING DIMENSIONS (unit: mm)

All dimensions are $\pm 0.20\text{mm}$ unless otherwise specified.

No Shield

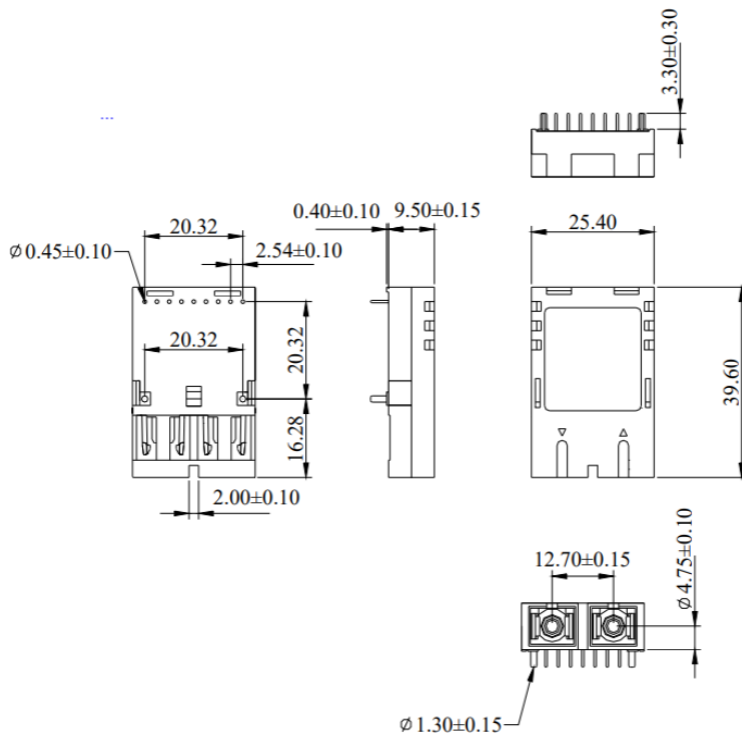

Backward Shield

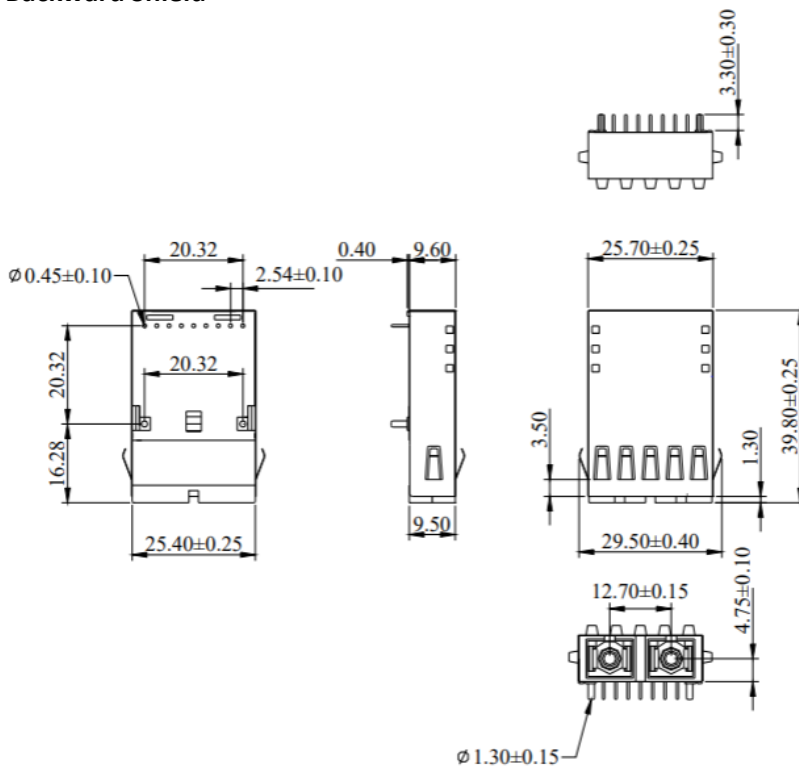

Lasermate Group, Inc.

19608 Camino De Rosa, Walnut, CA 91789, USA

Tel: (909)718-0999 | Fax: (909)718-0998 | E-mail: info@lasermate.com | URL: <http://www.lasermate.com>

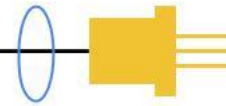

Forward Shield

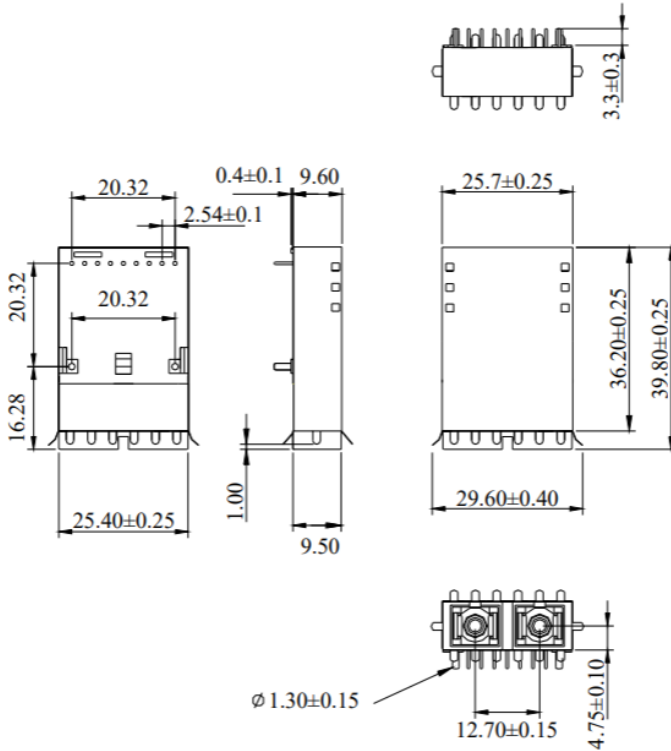

BLOCK DIAGRAM OF TRANSCEIVER

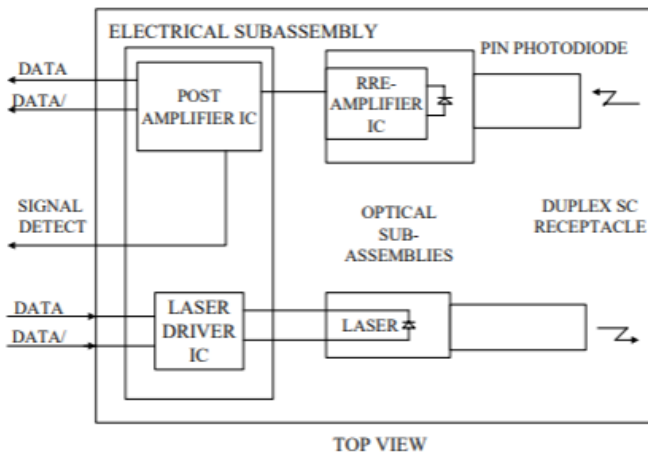

Transmitter Section - The transmitter section consists of a 1310nm InGaAsP in an optical subassembly (OSA) which mates to the fiber cable. The laser OSA is driven by a LD driver IC which converts differential input PECL logic signals into an analog laser driving current.

Receiver Section - The receiver utilizes an InGaAs PIN photodiode mounted together with a trans-impedance preamplifier IC in an OSA. This OSA is connected to a circuit providing post-amplification quantization, and optical signal detection.

Receiver Signal Detect - Signal Detect is a basic fiber failure indicator. This is a single-ended PECL output. As the input optical power is decreased, Signal Detect will switch from high to low (deassert point) somewhere between sensitivity and the no light input level. As the input optical power is increased from very low levels, Signal Detect will switch back from low to high (assert point). The assert level will be at least 1.0 dB higher than the deassert level.

Lasermate Group, Inc.

19608 Camino De Rosa, Walnut, CA 91789, USA

Tel: (909)718-0999 | Fax: (909)718-0998 | E-mail: info@lasermate.com | URL: <http://www.lasermate.com>

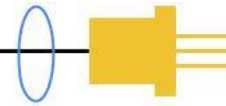

CONNECTION DIAGRAM

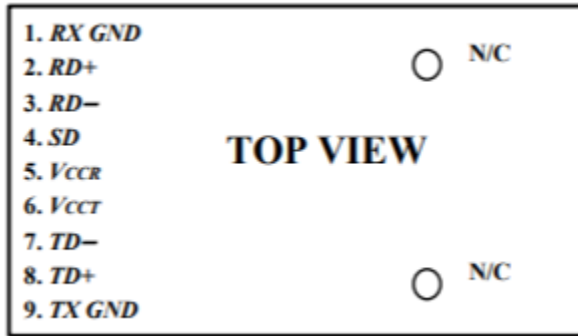

PIN	SYMBOL	DESCRIPTION
1	<i>RX GND</i>	Receiver Signal Ground. Directly connect this pin to the receiver ground plane.
2	<i>RD+</i>	<i>RD+</i> is an open-emitter output circuit. Terminate this high-speed differential PECL output with standard PECL techniques at the follow-on device input pin. (See recommended circuit schematic)
3	<i>RD-</i>	<i>RD-</i> is an open-emitter output circuit. Terminate this high-speed differential PECL output with standard PECL techniques at the follow-on device input pin. (See recommended circuit schematic)
4	<i>SD</i>	Signal Detect. Normal optical input levels to the receiver result in a logic “1” output, V_{OH} , asserted. Low input optical levels to the receiver result in a fault condition indicated by a logic “0” output V_{OL} , deasserted. Signal Detect is a single-ended PECL output. <i>SD</i> can be terminated with PECL techniques via $50\ \Omega$ to $V_{CCR} - 2\ \text{V}$. Alternatively, <i>SD</i> can be loaded with a $180\ \Omega$ resistor to <i>RX GND</i> to conserve electrical power with small compromise to signal quality. If Signal Detect output is not used, leave it open-circuited. This Signal Detect output can be used to drive a PECL input on an upstream circuit, such as, Signal Detect input or Loss of Signal-bar.
5	<i>V_{CCR}</i>	Receiver Power Supply. Provide +3.3 Vdc via the recommended receiver power supply filter circuit. Locate the power supply filter circuit as close as possible to the <i>V_{CCR}</i> pin.
6	<i>V_{CCT}</i>	Transmitter Power Supply. Provide +3.3 Vdc via the recommended transmitter power supply filter circuit. Locate the power supply filter circuit as close as possible to the <i>V_{CCT}</i> pin.
7	<i>TD-</i>	Transmitter Data In-Bar. Terminate this high-speed differential PECL input with standard PECL techniques at the transmitter input pin. (See recommended circuit schematic)
8	<i>TD+</i>	Transmitter Data In. Terminate this high-speed differential PECL input with standard PECL techniques at the transmitter input pin. (See recommended circuit schematic)
9	<i>TX GND</i>	Transmitter Signal Ground. Directly connect this pin to the transmitter signal ground plane. Directly connect this pin to the transmitter ground plane.

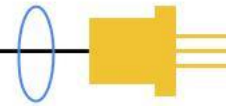

RECOMMENDED CIRCUIT SCHEMATIC

DC/DC Coupling

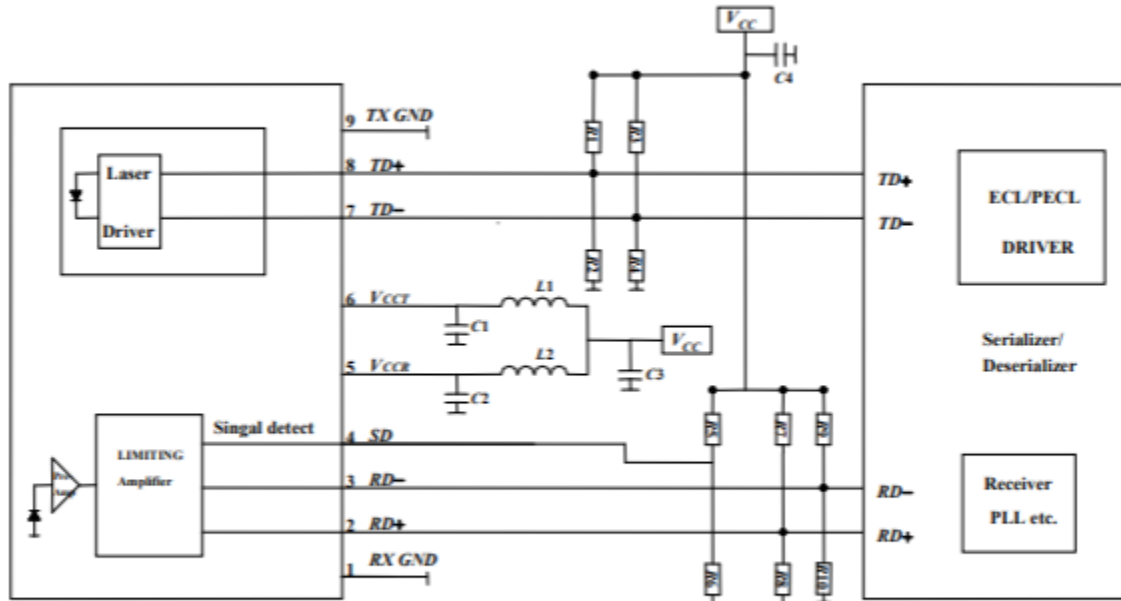

$$C1/C2/C4 = 0.1 \mu\text{F}$$
$$L1/L2 = 1 \mu\text{H}$$
$$R1/R3/R5/R7/R9 = 130 \Omega$$

$$C3 = 4.7 \mu\text{F}$$
$$R2/R4/R6/R8/R10 = 82 \Omega$$

In order to get proper functionality, a recommended circuit is provided in above recommended circuit schematic. When designing the circuit interface, there are a few fundamental guidelines to follow.

- (1) The differential data lines should be treated as 50 Ω Micro strip or strip line transmission lines. This will help to minimize the parasitic inductance and capacitance effects. Locate termination at the received signal end of the transmission line. The length of these lines should be kept short and of equal length.
- (2) For the high-speed signal lines, differential signals should be used, not single-ended signals, and these differential signals need to be loaded symmetrically to prevent unbalanced currents which will cause distortion in the signal.
- (3) Multi-layer plane PCB is best for distribution of VCC, returning ground currents, forming transmission lines and shielding. Also, it is important to suppress noise from influencing the fiber-optic transceiver performance, especially the receiver circuit.
- (4) A separate proper power supply filter circuits shown in Figure for the transmitter and receiver sections. These filter circuits suppress Vcc noise over a broad frequency range, this prevents receiver sensitivity degradation due to VCC noise.
- (5) Surface-mount components are recommended. Use ceramic bypass capacitors for the 0.1 μF capacitors and a surface-mount coil inductor for 1 μH inductor. Ferrite beads can be used to replace the coil inductors when using quieter VCC supplies, but a coil inductor is recommended over a ferrite bead. All power supply components need to be placed physically next to the VCC pins of the receiver and transmitter.
- (6) Use a good, uniform ground plane with a minimum number of holes to provide a low-inductance ground current return for the power supply currents.

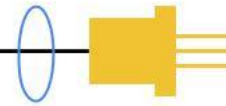

RECOMMENDED BOARD LAYOUT HOLE PATTERN

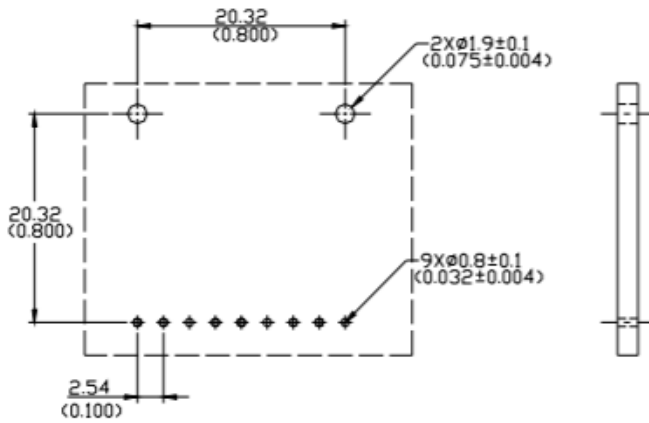

Unit : mm(inches)

This transceiver is compatible with industry standard wave or hand solder processes. After wash process, all moisture must be completely removed from the module. The transceiver is supplied with a process plug to prevent contamination during wave solder and aqueous rinse as well as during handling, shipping or storage.

Solder fluxes should be water-soluble, organic solder fluxes. Recommended cleaning and degreasing chemicals for these transceivers are alcohol's (methyl, isopropyl, isobutyl), aliphatics (hexane, heptane) and other chemicals, such as soap solution or naphtha. Do not use partially halogenated hydrocarbons for cleaning/degreasing.

EYE SAFETY MARK

The single-mode transceiver is a class 1 laser product. It complies with EN 60825-1 and FDA 21 CFR 1040.10 and 1040.11. In order to meet laser safety requirements, the transceiver shall be operated within the Absolute Maximum Ratings.

Required Mark

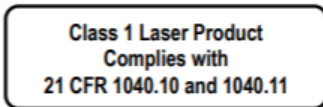

[Caution] All adjustments have been done at the factory before the shipment of the devices. No maintenance and user serviceable part is required. Tampering with and modifying the performance of the device will result in voided product warranty.

ORDERING INFORMATION

PART NUMBER	INPUT/OUTPUT	SIGNAL DETECT	CLIPPER/SHIELD	OPERATING TEMPERATURE
CS15D-12A-3U-PC-C	DC/DC	LVPECL	No Shield	0°C to 70°C
CS15D-12A-3U-PC-CB	DC/DC	LVPECL	Backward Clipper	0°C to 70°C
CS15D-12A-3U-PC-CF	DC/DC	LVPECL	Forward Clipper	0°C to 70°C
CS15D-12A-3U-PI-C	DC/DC	LVPECL	No Shield	-40°C to 85°C
CS15D-12A-3U-PI-CB	DC/DC	LVPECL	Backward Clipper	-40°C to 85°C
CS15D-12A-3U-PI-CF	DC/DC	LVPECL	Forward Clipper	-40°C to 85°C

Note: The specifications subject to change without notice.

Lasermate Group, Inc.

19608 Camino De Rosa, Walnut, CA 91789, USA

Tel: (909)718-0999 | Fax: (909)718-0998 | E-mail: info@lasermate.com | URL: <http://www.lasermate.com>