



Model No. LDV808Q2000WC
808nm High Power QCW Conduction-Cooled Vertical Array

The LDV-series high power packaged bars provide OEM customers with scalable power up to kilowatts for pumping, industrial and medical applications. The packaged laser bars can be configured for enhanced brightness through stacking, scaled linearly or vertically for optimized light and material integration.

FEATURES

- 808nm Conduction-Cooled Vertical Array
- QCW Operation
- High output power: 2000W
- Spectral width: <5 nm
- High reliability, High efficiency
- Modular and compact design for ease of integration
- Packaged 10mm laser diode bar



SPECIFICATIONS (T_c = 25°C)

ITEM	PARAMETER	LDV808Q2000WC	UNIT
OPTICAL PARAMETER	Center wavelength	808	nm
	Operation mode	QCW	-
	Output power	2000	W
	Output power/bar	100	W
	Spectral width	<5	nm
	Bar quantity	20	-
	Wavelength Temperature coefficient	0.28	nm/°C
	Pulse width	<500	µs
	Duty ratio	≤4	%
	Fast axis divergence	<39	deg
	Slow axis divergence	<10	deg
ELECTRICAL PARAMETER	Threshold current	<25	A
	Operating current	<110	A
	Operating voltage/Bar	<2.0	V
THERMAL PARAMETER	Operating temperature	15 to 35	°C
	Storage temperature	-10 to +60	°C



MECHANICAL OUTLINE (unit: mm)

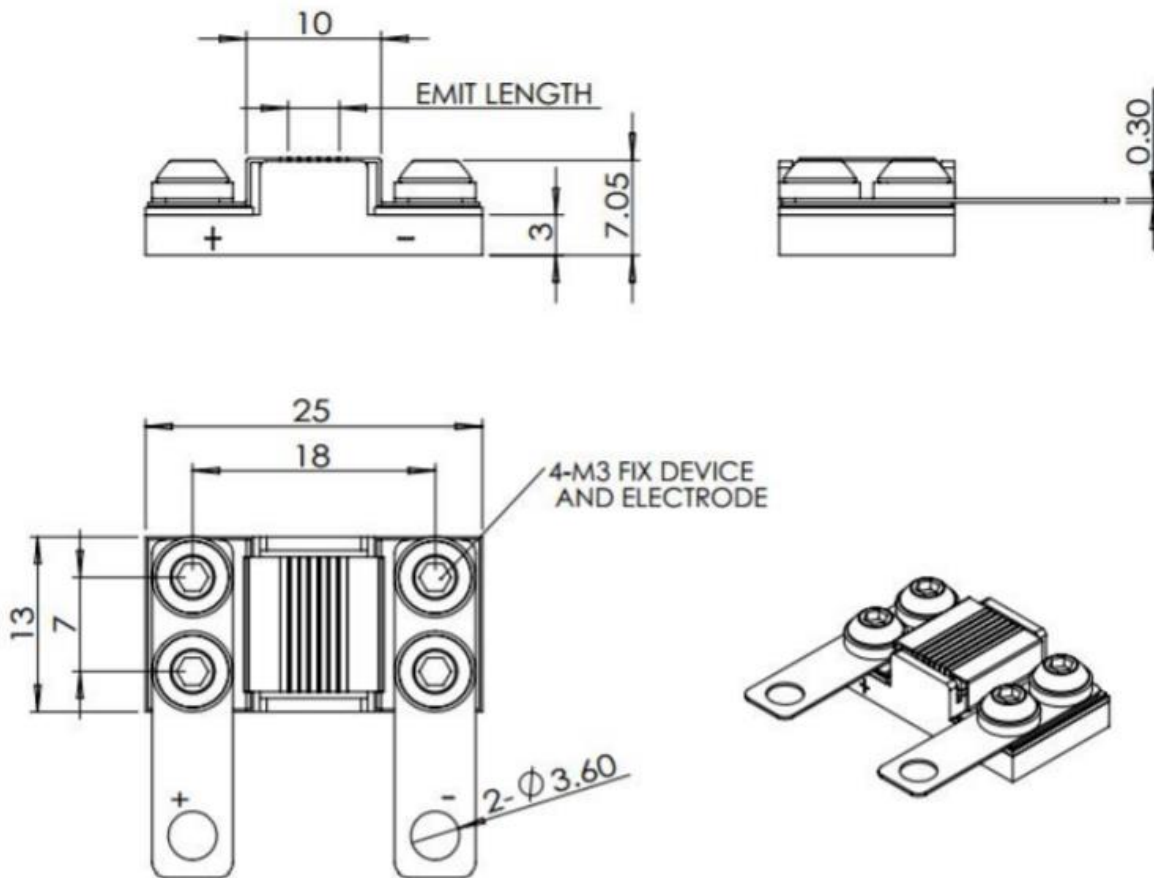

Notes:

1. The above specifications are subject to change without notice.
2. Please make sure that the laser diode is operated under the temperature between 15 °C and 35 °C, as high temperature will increase threshold current, decrease exchange rate and accelerate the aging.
3. Please take measures to avoid condensation, which will cause aging of laser diode.