



Model No. LD650A5C15 (LD-650-5A)
650nm 5mW 50°C Laser Diode in TO-18 Ø5.6mm Package

FEATURES

- 650nm 5mW Visible Laser Diode
- FFP single lateral mode
- High precision assembly
- High reliability
- Package: TO-18 (dia. 5.6mm)

APPLICATIONS

- General purpose red laser light source
- Industrial laser markers / measuring instruments
- Laser pointers

ABSOLUTE MAXIMUM RATINGS

PARAMETER	SYMBOL	CONDITION	RATING	UNIT
LIGHT OUTPUT POWER	P _O	CW	7	mW
REVERSE VOLTAGE (LD)	V _{RL}	-	2	V
REVERSE VOLTAGE (PD)	V _{RD}	-	30	V
FORWARD CURRENT (PD)	I _{FD}	-	10	mA
CASE TEMPERATURE	T _C	-	-10 to +50	°C
STORAGE TEMPERATURE	T _S	-	-40 to +85	°C

ELECTRICAL AND OPTICAL CHARACTERISTICS (T_C = 25 °C)

PARAMETER	SYMBOL	MIN.	TYP.	MAX.	UNIT	CONDITIONS
PEAK WAVELENGTH	λ	645	655	660	nm	P _O = 5mW
THRESHOLD CURRENT	I _{th}	-	18	25	mA	
OPERATING CURRENT	I _{op}	-	25	35	mA	P _O = 5mW
OPERATING VOLTAGE	V _{op}	-	2.2	2.5	V	P _O = 5mW
DIFFERENTIAL EFFICIENCY	η	0.4	0.7	1.1	mW/mA	P _O = 3-5mW
MONITOR CURRENT	I _m	0.05	0.2	0.4	mA	P _O = 5mW, V _{RD} = 5V
PARALLEL DIVERGENCE ANGLE	Θ _{//}	6	9	11	deg	
PERPENDICULAR DIVERGENCE ANGLE	Θ _⊥	24	28	38	deg	
PARALLEL FFP DEVIATION ANGLE	Δ Θ _{//}	-3	0	+3	deg	P _O = 5mW
PERPENDICULAR FFP DEVIATION ANGLE	Δ Θ _⊥	-3	0	+3	deg	
EMISSION POINT ACCURACY	Δx Δy Δz	-80	0	+80	um	

Note: The above specifications are subject to change without notice.





MECHANICAL OUTLINE (unit: mm)

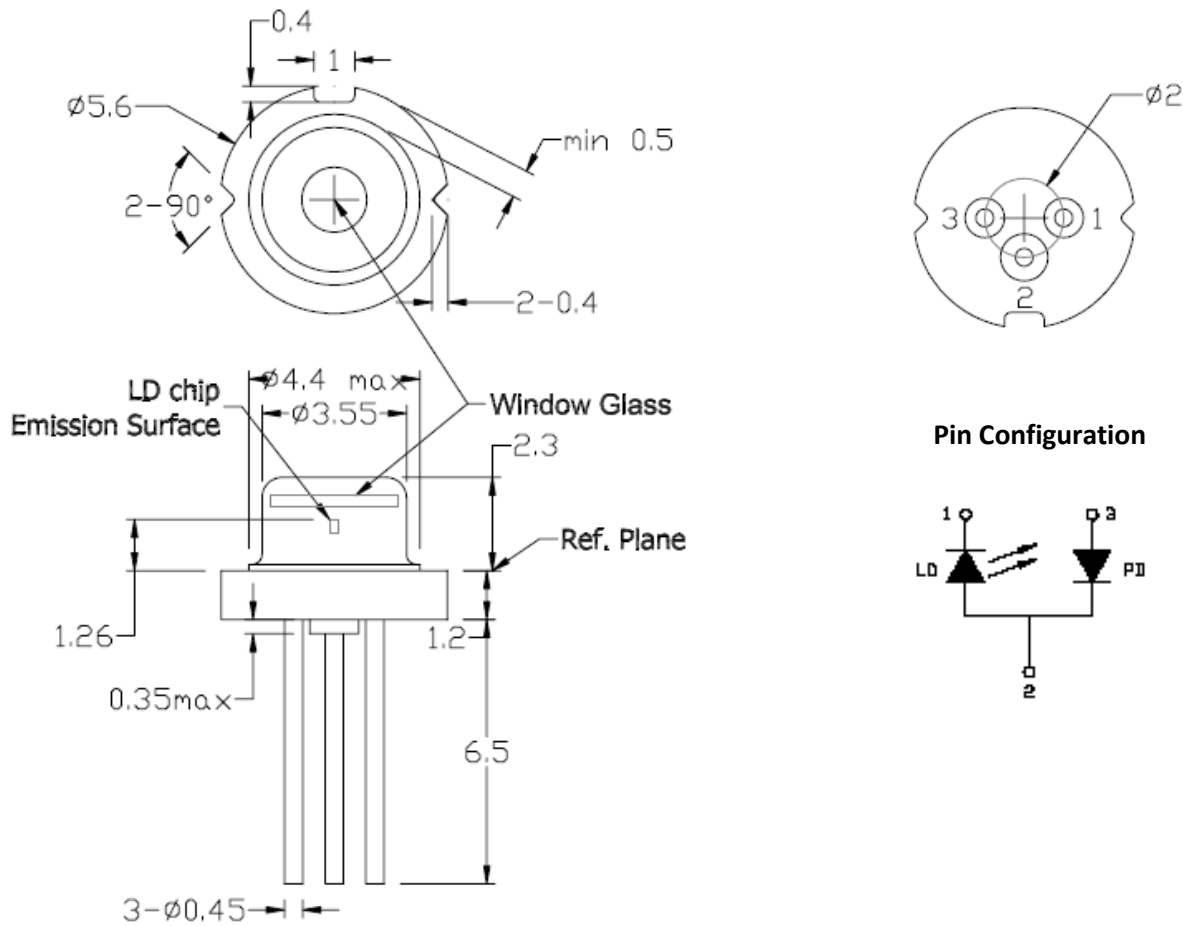

PRECAUTIONS

- Do not operate the device above maximum ratings. Doing so may cause unexpected and permanent damage to the device.
- Take precautions to avoid electrostatic discharge and/or momentary power spikes. A change in the characteristics of the laser or premature failure may result.
- Proper heat sinking of the device assures stability and lifetime. Always ensure that maximum operating temperatures are not exceeded.
- Observing visible or invisible laser beams with human eye directly, or indirectly, can cause permanent damage. Use a camera to observe the laser.
- No laser device should be used in any application or situation where life or property is at risk in the event of device failure.
- Specifications are subject to change without notice. Ensure that you have the latest specification by contacting us prior to purchase or use of the product.

Note: The above specifications are subject to change without notice.





TYPICAL CHARACTERISTICS

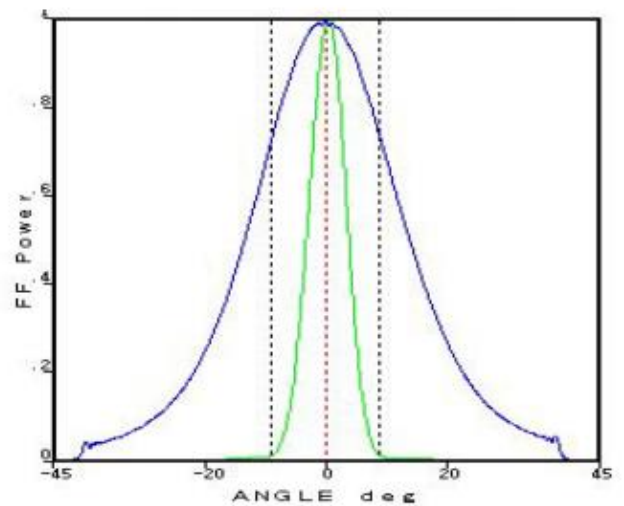
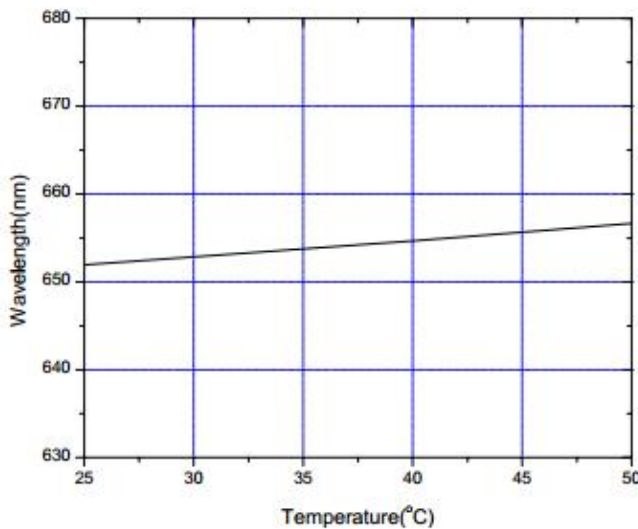
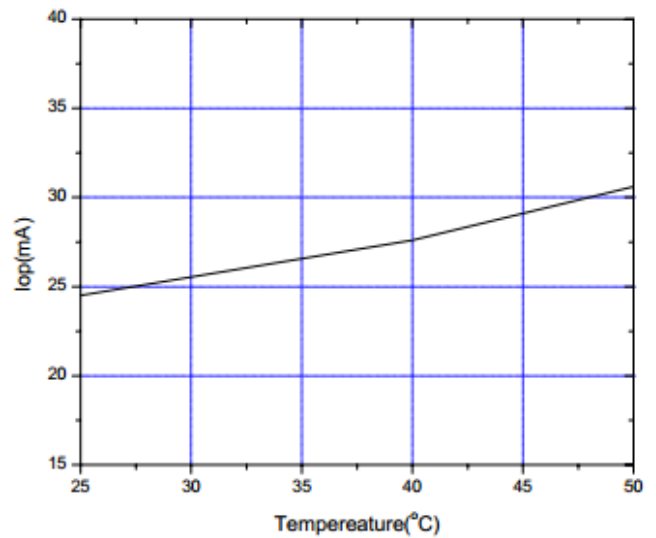
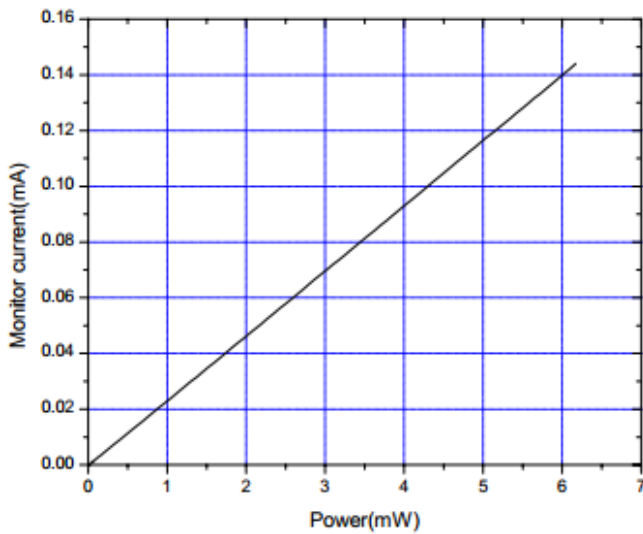
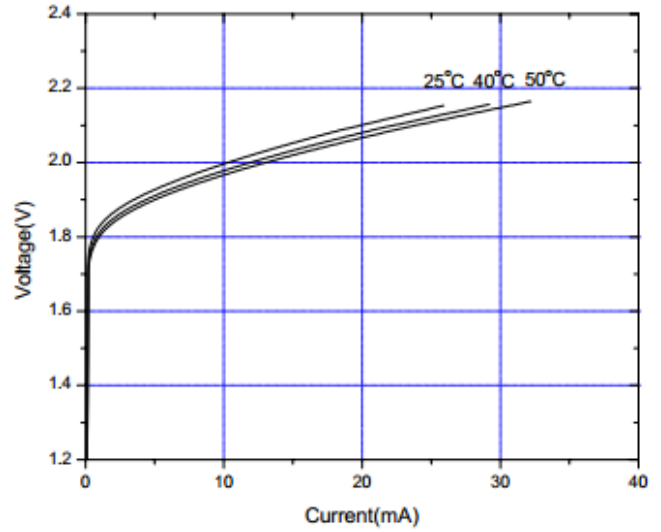
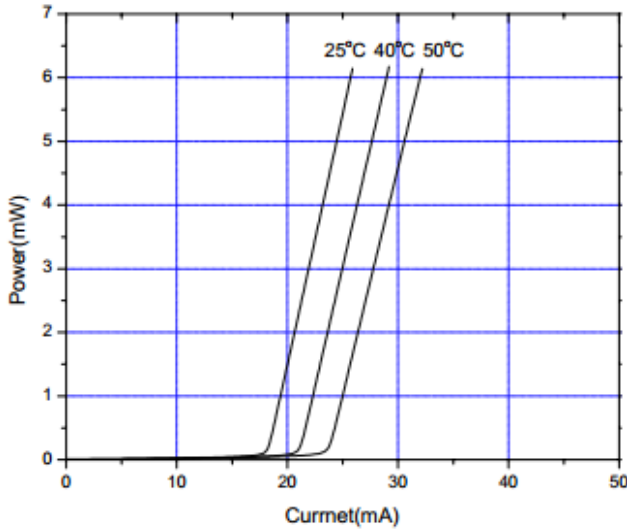

Note: The above specifications are subject to change without notice.

