



Model No. LD650A10C17
650nm 10mW 70°C Laser Diode in TO-18 Ø5.6mm Package

FEATURES

- 650m 10mW AlGaInP Visible Laser Diode
High temperature operation
Low current operation
Package: TO-18 (dia. 5.6mm)

APPLICATIONS

- Laser levelers
Industrial laser markers / measuring instruments
Bar code readers

ABSOLUTE MAXIMUM RATINGS

Table with 5 columns: PARAMETER, SYMBOL, CONDITION, RATING, UNIT. Rows include LIGHT OUTPUT POWER, REVERSE VOLTAGE (LD), REVERSE VOLTAGE (PD), FORWARD CURRENT (PD), CASE TEMPERATURE, STORAGE TEMPERATURE.

ELECTRICAL AND OPTICAL CHARACTERISTICS (Tc = 25 °C)

Table with 7 columns: PARAMETER, SYMBOL, MIN., TYP., MAX., UNIT, CONDITIONS. Rows include PEAK WAVELENGTH, THRESHOLD CURRENT, OPERATING CURRENT, OPERATING VOLTAGE, DIFFERENTIAL EFFICIENCY, MONITOR CURRENT, PARALLEL DIVERGENCE ANGLE, PERPENDICULAR DIVERGENCE ANGLE, PARALLEL FFP DEVIATION ANGLE, PERPENDICULAR FFP DEVIATION ANGLE, EMISSION POINT ACCURACY.

Note: The above specifications are subject to change without notice.





### MECHANICAL OUTLINE (unit: mm)

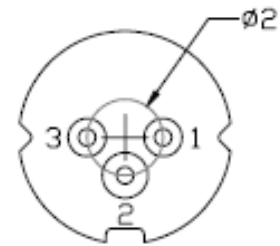
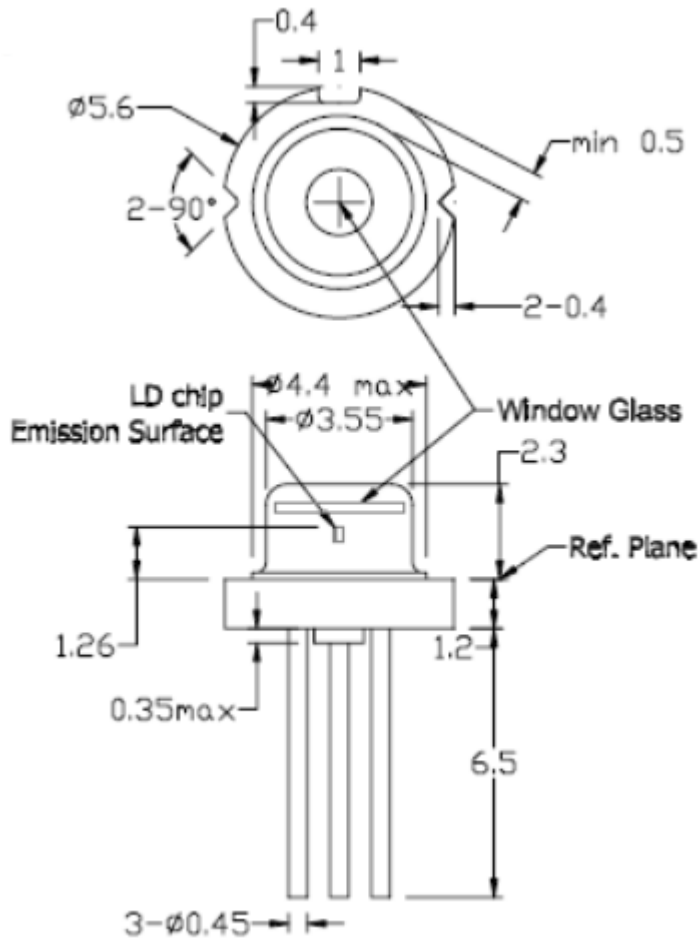

### Pin Configuration

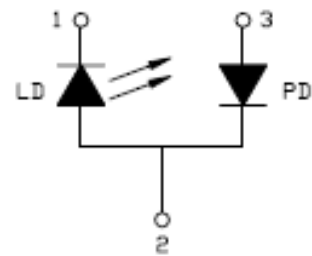

### PRECAUTIONS

- Do not operate the device above maximum ratings. Doing so may cause unexpected and permanent damage to the device.
- Take precautions to avoid electrostatic discharge and/or momentary power spikes. A change in the characteristics of the laser or premature failure may result.
- Proper heat sinking of the device assures stability and lifetime. Always ensure that maximum operating temperatures are not exceeded.
- Observing visible or invisible laser beams with human eye directly, or indirectly, can cause permanent damage. Use a camera to observe the laser.
- No laser device should be used in any application or situation where life or property is at risk in the event of device failure.
- Specifications are subject to change without notice. Ensure that you have the latest specification by contacting us prior to purchase or use of the product.

**Note: The above specifications are subject to change without notice.**





TYPICAL CHARACTERISTICS

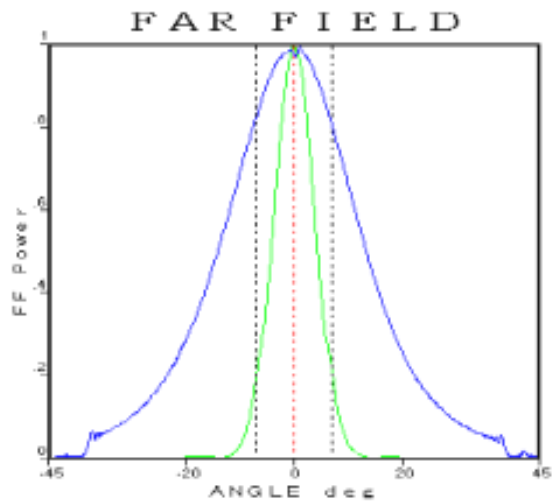
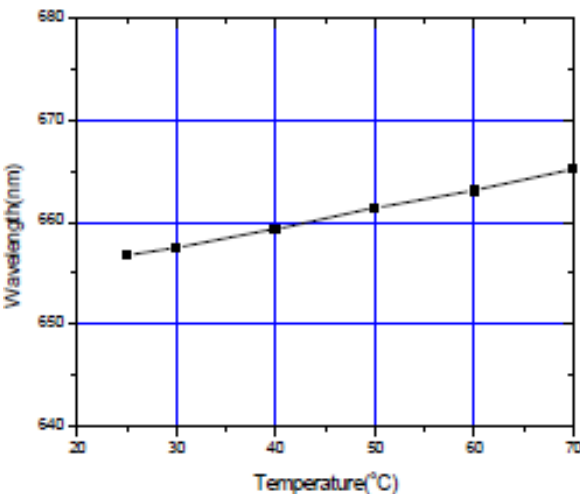
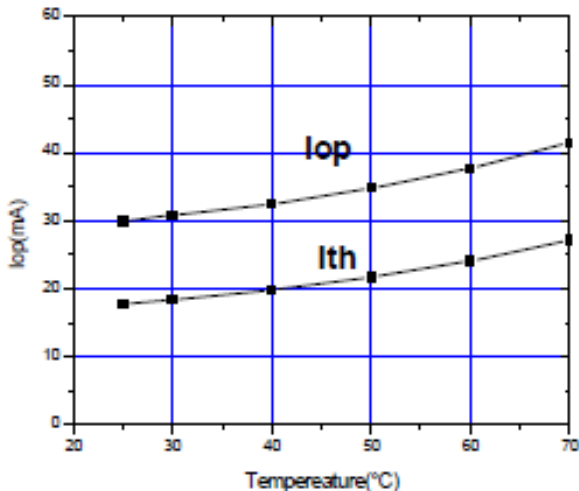
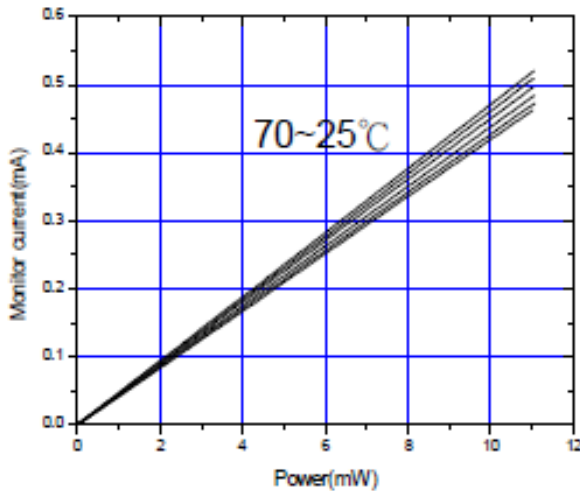
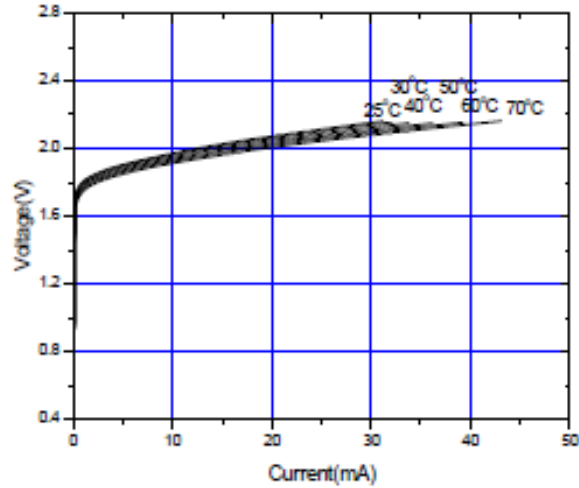
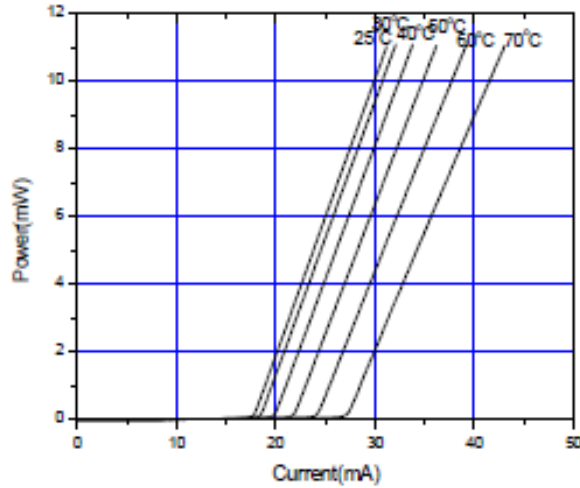

Note: The above specifications are subject to change without notice.

